

Agape tools 3:
Rubinetti/Taps/Armaturen/Robinetterie
/Grifería → pag 004, **Accessori/Accessories/ Acces-**
soires/Accessoires/Accesorios → pag 066,
Complementi/Extras/Zubehör/Compléments
/Complementos → pag 094.

Designed by:
Benedini Associati,
Daniele Borin/Nicola
Gibertini/Mattia Vittori,
Fabio Bortolani,
/Ermanno Righi,
Alessandro Farnetti,
Giulio Gianturco,
Konstantin Grcic,
Nicolas Gwenaël
/Curiosity,
Maurizio Negri,
UT Agape.

Un mondo in cui immergersi

Un mondo più bello, abitato da forme amichevoli ed affascinanti, ricco di possibilità ed emozioni. È il bagno Agape: un ambiente accogliente, luminoso e creativo nel quale la semplicità nasce da uno studio approfondito, l'estetica non è mai separata dalla funzione, la natura e la tecnologia convivono in armonia. Agape vi dà il benvenuto in questo mondo e vi invita a viverlo con libertà e piacere: in tutti i suoi momenti ed elementi.

Indice analitico → 117
 Glossario materiali → 120

Immerse yourself in a new world

A more attractive world, inhabited by friendly and appealing shapes, rich in possibilities and emotions. This is the Agape bathroom: a welcoming, light-filled and creative room in which simplicity is born of in-depth - research, aesthetics is never separated from function and nature and technology live together in harmony. Agape welcomes you to this world and invites you to experience it with freedom and enjoyment, in all its moments and in all its parts.

Contents → 117
 Glossary of materials → 120

Eine Welt, in die man eintauchen kann

Eine schönere Welt, bewohnt von freundlichen und faszinierenden Formen, reich an Möglichkeiten und Emotionen. So ist ein Bad von Agape: ein gemütliches Ambiente, hell und kreativ, in dem Schlichtheit durch gründliche Studien entsteht, Ästhetik stets mit Funktion verbunden ist und Natur und Technologie in Harmonie nebeneinander bestehen. Agape heißt Sie in dieser Welt willkommen, die Sie in aller Freiheit und mit Freude erleben mögen: in allen ihren Momenten und Elementen.

Inhalt → 117
 Glossar Materialien → 120

Un monde où s'immerger

Un monde plus beau, habité de formes amicales et fascinantes, riche de possibilités et d'émotions. Telle est la salle de bain Agape: un milieu accueillant, lumineux et créatif dans lequel la simplicité naît d'une étude approfondie, l'esthétique n'est jamais séparée de la fonction, la nature et la technologie cohabitent en harmonie. Agape vous donne la bienvenue dans ce monde et vous invite à le vivre avec liberté et volupté: dans tous ses instants et éléments.

Index → 117
 Glossaire des matériaux → 120

Un mundo en el cual sumergirse

Un mundo más hermoso en el que viven formas afables y fascinantes, rico en posibilidades y emociones. Es el baño Agape: un espacio acogedor, luminoso y creativo en el que la sencillez nace de un estudio profundo, la estética nunca se separa de la función y la naturaleza convive armoniosamente con la tecnología. Agape les da la bienvenida en este mundo y les invita a vivirlo con libertad y placer: en todos sus momentos y con todos sus elementos.

Índice → 117
 Glosario de materiales → 120

Una collezione con il giusto grado di tecnologia e di design, per completare e personalizzare il bagno Agape. Rubinetti esterni, a incasso, monocomando o con due comandi. Realizzati in ottone, acciaio inox o alluminio, sono caratterizzati da un design originale e da una qualità totale.

A collection with the right mix of technology and design, to complement and customise your Agape bathroom. External and recessed taps, with single or dual controls, produced in brass, stainless steel or aluminium, and featuring an original design and absolute quality.

Eine Kollektion mit der richtigen Mischung von Technologie und Design, um das Badezimmer Agape im individuellen Stil zu komplettieren. Aufputz- oder Unterputzarmaturen, Einhand- oder Zweihandbedienung. Alle im eigenwilligen Design und von hochwertiger Qualität, werden sie aus Messing, rostfreiem Stahl oder Aluminium hergestellt.

Une collection réunissant la juste dose de technologie et de design, pour compléter et personnaliser la salle de bains Agape. Robinets apparents, encastrés, monocommande ou bicommande. Réalisés en laiton, acier inox ou aluminium, ils sont caractérisés par un design original et une qualité totale.

Una colección con mezcla exacta de tecnología y diseño, para completar y personalizar el baño Agape. Grifos de superficie o encastrados, mono o bimando. Fabricados en latón, acero inoxidable o aluminio, y caracterizados por un diseño original y total calidad.

pag

006, 008, 010, 012, 014, 016, 018
020, 022, 024, 026
028, 030, 032, 034, 036, 038
040, 042, 044, 046, 048, 050, 052

Fez
Memory
Sen
Square

Complementi per rubinetteria / Tapware extras

054 Al dente
056 ARUB 400 / 401
058 Hydro
060 Kaa
062, 064 Doccette e soffioni / Handheld showers and shower heads

Agape tools 3:
Rubinetti / Taps /
Armaturen / Robinet-
terie / Grifería → pag 006.

Fez / 1999

Una forma inconfondibile per una collezione completa di miscelatori monoforo per lavabo, disponibili con tre maniglie e in diverse dimensioni. Tutti i gruppi sono realizzati in ottone cromato lucido o laccati in bianco o nero.

An unmistakable shape for a complete collection of single-hole basin mixer taps, available with three different types of handle and in various sizes. All tap sets are made of polished chrome-plated brass, or with a white or black lacquer finish.

Eine unverkennbare Form für eine vollständige Kollektion von Einhandmischern für das Waschbecken, mit drei Arten von Bedienungshebeln und in verschiedenen Maßen. Alle Armaturen aus verchromtem Messing glänzend weiß oder schwarz lackiert.

Une forme incomparable pour une collection complète de mitigeurs monotrou pour lavabos, disponibles avec trois types de leviers et en différentes dimensions. Tous les groupes sont réalisés en laiton chromé poli ou en laqué blanc ou noir.

Una forma inconfundibile para una colección completa de mezcladores monomando para lavabo, disponibles con tres tipos de manillas y en distintos tamaños. Todos los grupos están fabricados en latón cromo brillo o barnizados en blanco o negro.

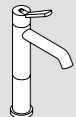

design Benedini Associati

 $\frac{115}{5\frac{7}{8}}$ - $\frac{150}{4\frac{1}{2}}$

 $\frac{265}{10\frac{3}{8}}$ - $\frac{315}{12\frac{3}{8}}$
 $\frac{115}{4\frac{1}{2}}$ - $\frac{150}{5\frac{7}{8}}$

 $\frac{165}{6\frac{1}{2}}$

 $\frac{64}{2\frac{1}{2}}$

 $\frac{91}{3\frac{5}{8}}$

Finiture / Finishes



Nivis
lavabo, washbasin,
waschbecken, lavabo,
lavabo
→ Tools vol. 1



Flat XL
programma, range,
programm, programme,
programa
→ Tools vol. 5



Fez / 1999

Un gruppo lavabo da incasso formato da miscelatore monocomando e bocca di erogazione, due tipologie di maniglia e bocche in varie misure.

A recessed basin tap set consisting of a single-control mixer and outlet spout, with three types of handle and spouts in various sizes.

Eine Unterputzarmatur für Waschbecken mit Einhandmischer und Wasserauslauf, drei Arten von Bedienungshebeln und Ausläufen in verschiedenen Maßen.

Un groupe lavabo encastrable formé d'un mitigeur monocommande et d'un bec d'écoulement, trois types de leviers et becs de dimensions diverses.

Grifería de encastrado para lavabo formada por mezclador monomando y boca de erogación, tres tipos de manillas y bocas de varios tamaños.



design Benedini Associati



Finiture / Finishes



○
Vieques
lavabo, washbasin,
waschbecken, lavabo,
lavabo
→ Tools vol. 1

Fez / 1999

Fez è un concetto di design versatile che si adatta a diverse situazioni, con una personalità unica: dalla versione a terra per completare un lavabo freestanding, al modello da bidet.

Fez is a versatile design concept adaptable to a range of situations, but with a unique personality: from the floor-mounted version to complete a freestanding washbasin, to the model for bidets.

Fez zeichnet sich durch ein vielseitiges Design aus, das sich an unterschiedliche Gegebenheiten mit einer starken Persönlichkeit anpasst: von der Standarmatur für einen freistehenden Waschtisch bis zum Modell für das Bidet.

Fez est un concept de design polyvalent qui s'adapte à différents contextes avec une personnalité unique: de la version au sol pour compléter un lavabo colonne, au modèle pour bidet.

Fez es un concepto de diseño versátil que se adapta a distintas situaciones, con una personalidad única: desde la versión apoyada en el suelo para un lavabo independiente hasta el modelo para bidé.



design Benedini Associati

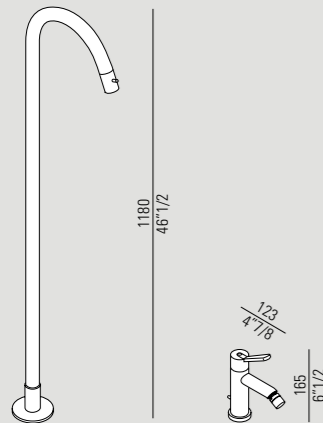

Finiture / Finishes



Nivis

lavabo, washbasin,
waschbecken, lavabo,
lavabo

→ Tools vol. 1

Fez / 1999

Fez rivela la sua flessibilità anche nella vasca da bagno e nello spazio doccia, con gruppi specifici sempre caratterizzati da un inconfondibile design.

Fez proves equally flexible in the bathtub or shower, with purpose-made sets, all featuring the same unmistakable design.

Vielseitigkeit beweist Fez auch bei Badewannen und Duschen mit spezifischen Armaturen, die durch ein unnachahmliches Design bestechen.

Fez révèle sa flexibilité aussi pour la baignoire et l'espace douche, avec des groupes spécifiques toujours caractérisés par un design unique.

Fez revela su flexibilidad también en la bañera y en el espacio para la ducha, con grupos específicos que se caracterizan por un diseño inconfundible.



design Benedini Associati

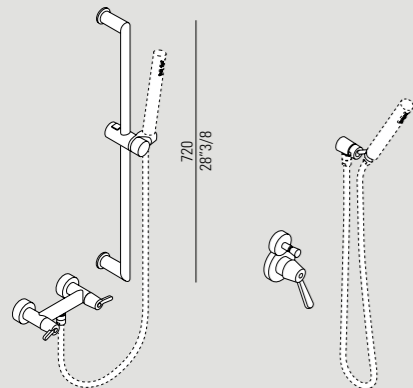

Finiture / Finishes



Fez / 1999

Versione a pavimento del rubinetto Fez: un pezzo importante che caratterizza l'intera stanza da bagno.

Floor-mounted version of the Fez tap: a striking piece that stamps its character on the entire bathroom.

Fez in der Ausführung als Standarmatur: ein prägendes Element, das dem Badezimmer einen besonderen Charakter verleiht.

Version au sol du robinet Fez. Une pièce importante qui caractérise toute la salle de bains.

Grifería Fez a suelo: una pieza importante que personaliza todo el cuarto de baño.



design Benedini Associati

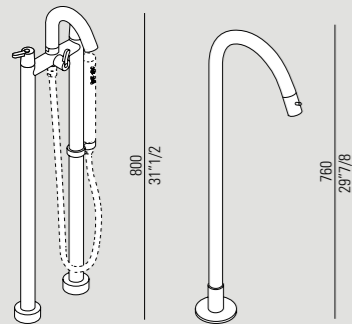

Finiture / Finishes



○
Slim
specchio, *mirror*,
spiegel, *miroir*, *espejo*

○
Normal
vasca, *bathub*, *badewanne*,
baignoire, *bañera*
→ Tools vol. 2

Fez / 1999

Una proposta completa di rubinetteria per ogni esigenza nell'ambiente bagno, nelle versioni cromato lucido, o verniciato in bianco o nero.

A complete range of taps for all bathroom needs, in polished chrome or with a white or black painted finish.

Eine komplette Linie von Armaturen für jeden Bedarf im Badezimmer, in den Ausführungen verchromt glänzend weiß oder schwarz lackiert.

Une proposition complète de robinetterie pour toutes les exigences de la salle de bains dans les versions en chromé poli, ou laqué blanc ou noir.

Una propuesta completa de grifería para cualquier exigencia en el espacio baño, en las versiones cromo brillo, o lacado en blanco o negro.

Lavabo / Washbasin

ARUB10012SL_ / ARUB100120L_
ARUB10015SL_ / ARUB100150L_

ARUB102150L_

ARUB10112SL_ / ARUB101120L_
ARUB10115SL_ / ARUB101150L_

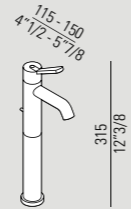
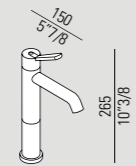
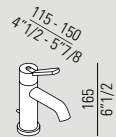

ARUB120150C_ / ARUB120200C_
/ ARUB120250C_

ARUB130150L_ / ARUB130200L_
/ ARUB130300L_

ARUB1460000_

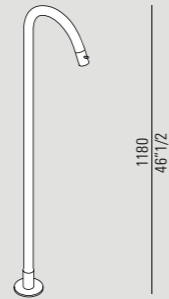
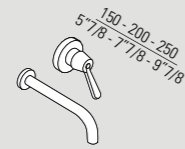
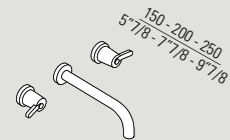

Bidet / Bidet

ARUB07012SL_

Doccia / Shower

.CRUB0900L_

.CRUB0920L_

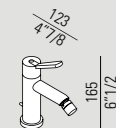

Doccia / Shower

.CRUB0929L_

.CRUB0928L_

ARUB060000L_

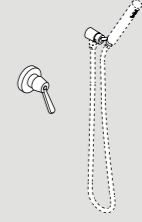
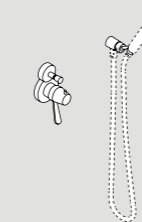
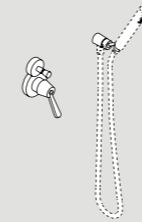

ARUB063000L_

ARUB269000L_

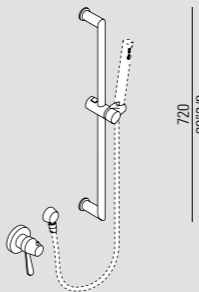
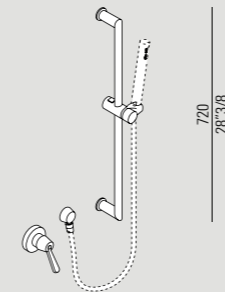

ARUB261000L_

ARUB263000L_

ARUB265000L_

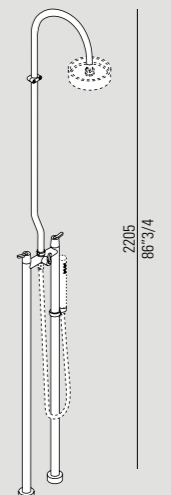
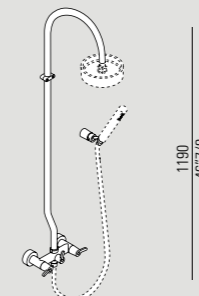
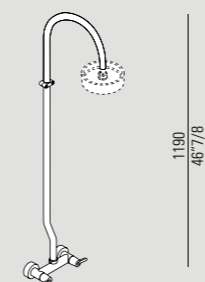

Vasca / Bathtub

ARUB050000L_

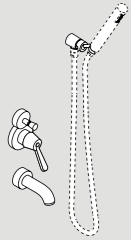

ARUB190000C_

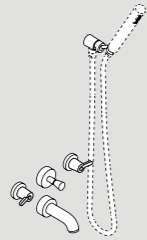

ARUB051000L_

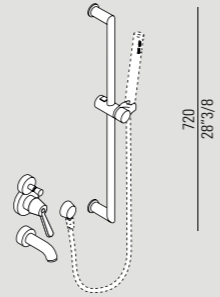

ARUB191000C_

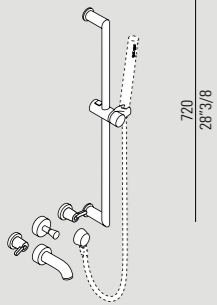

ARUB1400000_

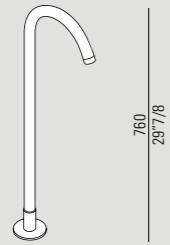

ARUB1450000_

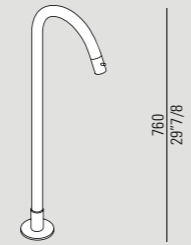

ARUB170000C_

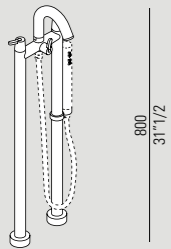

ARUB170W000C_



Memory / 2009

Tradizione e attualità si fondono in Memory, una collezione che si ispira al passato per completare e personalizzare il bagno contemporaneo. Realizzati in ottone cromato, sono caratterizzati dalla maniglia a croce.

Memory blends tradition with modernity, giving a collection inspired by the past to complete and customise the contemporary bathroom. Made of chrome-plated brass, they feature a cross headed handle.

Tradition und Aktualität verschmelzen in Memory, Armaturen, die sich von der Vergangenheit inspirieren lassen, um Badezimmer mit zeitgemäßer Persönlichkeit zu vervollständigen. Hergestellt aus verchromtem Messing, mit Bedienungshebel in charakteristischer Kreuzform.

La tradition et la modernité se fondent dans Memory, une collection qui s'inspire du passé pour compléter et personnaliser la salle de bains contemporaine. Réalisés en laiton chromé, ils sont caractérisés par la poignée en forme de croix.

Tradición y actualidad se unen en Memory, una colección que se inspira en el pasado para completar y personalizar el baño contemporáneo. Fabricados en latón cromado, se caracterizan por la manilla cruciforme.



design Benedini Associati

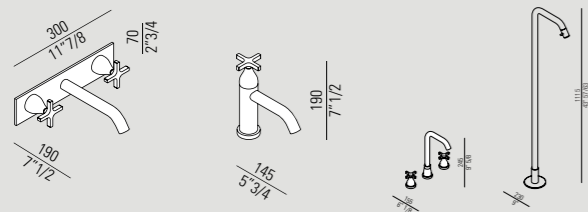

Memory / 2009

L'essenziale gruppo doccia da parete è fortemente caratterizzato dalla forma a croce delle manopole.

This essential wall-mounted shower set features a bold cross headed handle.

Die minimalistische Wandarmatur erhält durch die Kreuzform der Bedienungshebel den besonderen Charakter.

Le groupe de douche mural, aux lignes essentielles, est fortement caractérisé par les poignées en forme de croix.

La forma cruciforme de sus mandos distingue a esta grifería a pared.



design Benedini Associati

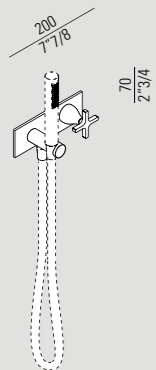

Memory / 2009

Diverse soluzioni studiate per la vasca bagno: a parete o a pavimento, con o senza doccetta flessibile integrata.

A range of solutions created for the bathtub: wall- or floor-mounted, with or without an integrated flexible hand shower.

Verschiedene Lösungen für die Badewanne: Wand- oder Standarmatur, mit oder ohne integrierte Handbrause.

Différentes solutions sont proposées pour la baignoire : version murale, au sol, avec ou sans douchette flexible intégrée.

Varias soluciones pensadas para la bañera: a pared o a suelo, con o sin duchador flexible integrado.



design Benedini Associati

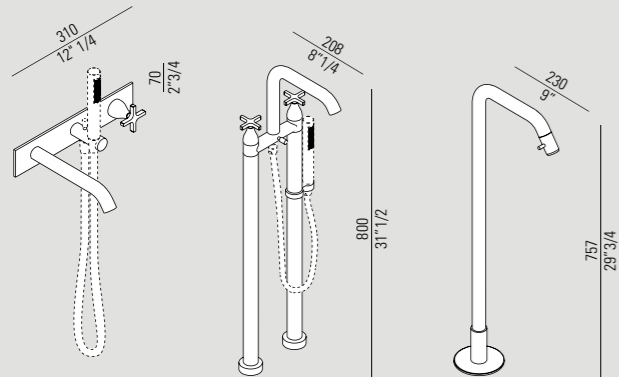

○
Deep
 vasca, bathtub, badewanne,
 baignoire, bañera
 → Tools vol. 2

Memory / 2009

Realizzati in ottone cromato, i rubinetti Memory si distinguono per il design a croce delle manopole e per gli aeratori a scomparsa.

Memory taps in chrome-plated brass feature distinctive cross headed handles and hidden aerators.

Die Armaturen Memory aus verchromtem Messing werden durch die kreuzförmigen Bedienungshebel und unsichtbar eingebaute Perlatoren optisch geprägt.

Réalisés en laiton chromé, les robinets Memory sont caractérisés par le design des poignées en croix et par les aérateurs invisibles.

Fabricada en latón cromado, la grifería Memory se distingue por el diseño cruciforme de sus mandos y por sus aireadores invisibles.

* con cartuccia progressiva

* with progressive cartridge

* mit progressiver Kartusche

* avec cartouche progressive

* con cartucho progresivo

Lavabo / Washbasin

* ARUB1035S

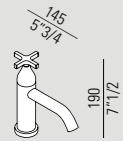

* ARUB1071S

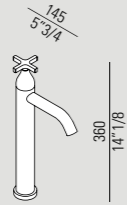

* ARUB1079S

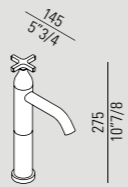

ARUB1039S

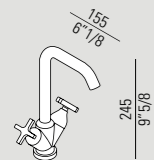

ARUB1030S

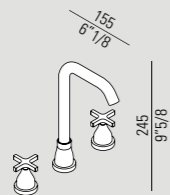

ARUB1031S

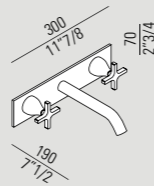

* ARUB1036S

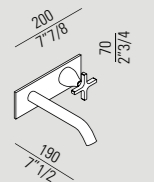

ARUB1087S

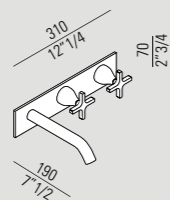

* ARUB1038S

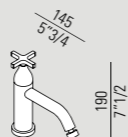

Vasca / Bathtub

* ARUB1076S

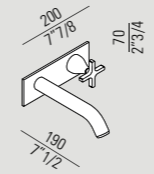

ARUB1089S

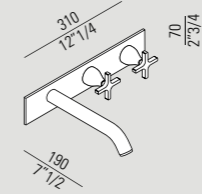

* ARUB1077S

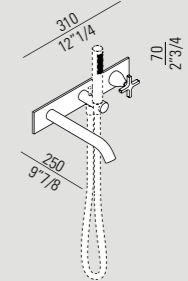

ARUB1040S

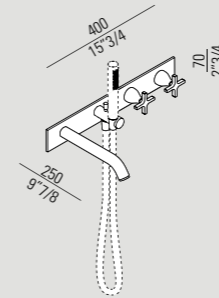

ARUB1091S

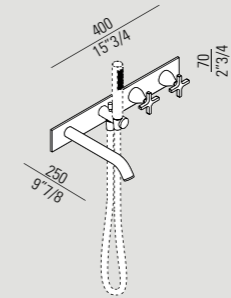

ARUB1078S

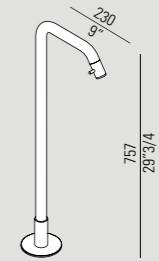

Vasca Doccia / Bathtub Shower

ARUB1033S

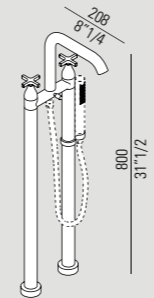

* ARUB1032S / ARUB1085S / ARUB1086S



* ARUB1075S

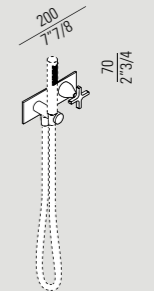

* ARUB1034S

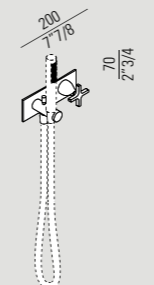

ARUB1088S

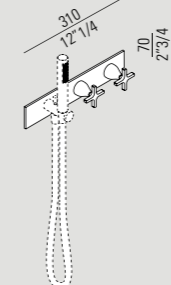

ARUB1074S / ARUB1073S



Sen / 2008

Sintesi di spirito orientale e tecnologia occidentale, Sen integra molteplici funzioni in una linea di elementi indipendenti, liberamente componibili e fortemente caratterizzanti, anche grazie alla matericità dell'alluminio spazzolato nero (grigio a richiesta).

A combination of Eastern spirit and Western technology, Sen incorporates multiple functions in a line of independent components which can be freely combined to make a distinct style statement, further enhanced by the striking texture of the black brushed aluminium (grey on demand).

Sen, Synthese aus östlicher Philosophie und westlicher Technik, vereinigt vielfältige Funktionen in einer Reihe unabhängiger Elemente, die frei miteinander kombinierbar sind und starke Akzente setzen, auch durch den stofflichen Charakter von gebürstetem Aluminium in schwarzer Farbe Ausführung (grau auf Anfrage).

Synthèse d'esprit oriental et de technologie occidentale, Sen intègre de multiples fonctions dans une ligne d'éléments indépendants, librement composables et fortement caractérisants, y compris grâce à l'effet matière de l'aluminium brossé noir (grise à la demande).

Síntesis de espíritu oriental y tecnología occidental, Sen integra múltiples funciones en una línea de elementos independientes, de libre composición y con personalidad bien definida, gracias también a la consistencia materica del aluminio cepillado negro (gris bajo petición).

– selezione, *selection*
ADI Design Index, 2009



Spoon XL
lavabo, washbasin,
waschbecken, lavabo,
lavabo
→ Tools vol. 1

design Nicolas Gwenaël, Curiosity

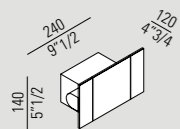

Finiture / Finishes



In-Out
lavabo, washbasin,
waschbecken, lavabo,
lavabo
→ Tools vol. 1

Sen / 2008

Il design minimale di Sen trova ulteriori declinazioni nelle versioni monoforo per lavabo proposte in due altezze per miscelatori su piano e una per miscelatore a pavimento.

Sen's minimal design is further interpreted in the single-hole versions for washbasin, available in two heights for basin-mounted mixer taps and one for a floor-mounted mixer.

Weitere Varianten des minimalistischen Designs von Sen in den Einloch-mischern für Waschbecken, in zwei Höhen für deckmontierte und einer Höhe für Standarmatur.

Le design minimaliste de Sen trouve de nouvelles déclinaisons dans les versions monotrou pour lavabo proposées en deux hauteurs pour mitigeurs sur plan et pour mitigeur au sol.

El diseño minimalista de Sen se reinterpreta en las versiones monomando para lavabo, disponibles en dos alturas diferentes: una para mezcladores sobre encimera y la otra para mezcladores a suelo.



design Nicolas Gwenael, Curiosity

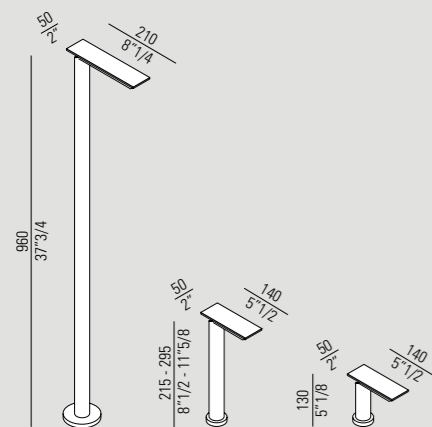

Finiture / Finishes



Vieques
lavabo, washbasin,
waschbecken, lavabo,
lavabo
→ Tools vol. 1



Sen / 2008

Una duplice proposta per la vasca: a parete con un completo sistema modulare di rubinetteria e accessori, oppure a pavimento con un unico pezzo essenziale e importante.

Two proposals for the bathtub: a complete modular wall-mounted system of taps and accessories, or floor-mounted as a single, bold, essential element.

Ein doppelter Vorschlag für die Badewanne: ein komplettes modulares System von Armaturen und Zubehör für Wandmontage, oder eine Standarmatur, aus einem einzigen Element im minimalistischen, den Raum prägenden Design.

Une double proposition pour la baignoire : version murale avec un système modulaire complet incluant robinetterie et accessoires, ou au sol avec une pièce unique, essentielle et importante.

Una doble propuesta para la bañera: versión de pared con un sistema modular con grifería y accesorios, o a suelo, con una pieza única, esencial e importante.



Spoon XL
vasca, bathtub, badewanne,
baignoire, bañera
→ Tools vol. 2

design Nicolas Gwenael, Curiosity

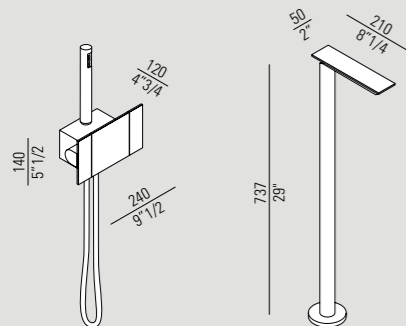

Finiture / Finishes



O.L.C
accessori, accessories,
accessoires, accesorios
→ Tools vol. 3



In-Out
vasca, bathtub, badewanne,
baignoire, bañera
→ Tools vol. 2



○

Spoon XL
vasca, bathtub, badewanne,
baignoire, bañera
→ Tools vol. 2

Sen / 2008

Sen completa e personalizza lo spazio doccia con un elemento orizzontale o una colonna verticale a cui si possono affiancare gli altri elementi dedicati a questo spazio di benessere e rigenerazione.

Sen completes and customises the shower space with a horizontal element or a vertical column, which can be combined with complementary elements dedicated to this area of well-being and regeneration.

Sen vervollständigt die Dusche nach individuellem Geschmack durch ein horizontales Element oder eine vertikale Säule, die durch weitere Elemente ergänzt werden kann, um diesen Wohlfühlbereich zusätzlich zu bereichern.

Sen complète et personnalise l'espace douche avec un élément horizontal ou une colonne verticale auxquels peuvent être associés les autres éléments dédiés à cet espace de bien-être et de régénération.

Sen completa y personaliza el espacio ducha con un elemento horizontal o de columna vertical, con los que se pueden combinar los demás elementos dedicados a este espacio de bienestar y regeneración.

**Flat D**

doccia, shower, dusche, douche, ducha
→ Tools vol. 2

design Nicolas Gwenael, Curiosity

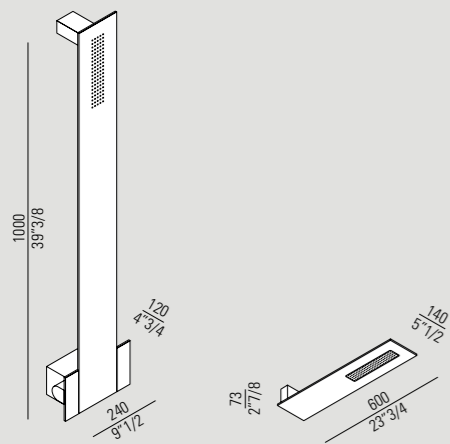

Finiture / Finishes



Sen / 2008

La rubinetteria e gli accessori Sen sono realizzati in alluminio anodizzato, con finitura spazzolato nero (grigio a richiesta). Per un corretto montaggio utilizzare la barra in acciaio da incassare nella muratura che permette di stabilire perfettamente la distanza tra due gruppi ad incasso o collegati da accessori.

Sen taps and accessories are made of anodised aluminium, with a black brushed finish (grey on demand). For correct installation use the steel bar to be immured, that permits to define exactly the distance between two built-in tap sets even if connected by accessories.

Armaturen und Accessoires Sen sind aus eloxiertem Aluminium, Oberfläche mit schwarz gebürsteter Ausführung (grau auf Anfrage). Für korrekte Montage die in die Mauer einzulassende Stahlschiene verwenden, zur genauen Bestimmung des Abstands zwischen zwei Unterputzarmaturen, auch wenn diese durch Accessoires verbunden sind.

La robinetterie et les accessoires Sen sont réalisés en aluminium anodisé, avec finition brossée noire (grise à la demande). Pour un correct montage utiliser la barre en acier à encastrer dans le mur, qui permet d'établir parfaitement la distance entre deux groupes à encastrement ou joints par des accessoires.

La grifería y los accesorios Sen están realizados en aluminio anodizado, con acabado cepillado negro (gris bajo petición). Para un correcto montaje utilizar la barra de acero para encastrar en el muro, que permite definir perfectamente la distancia entre dos grupos de encastre o conectados por accesorios.

Lavabo Bidet / Washbasin Bidet

ASEN0910

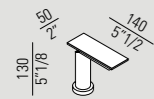

ASEN0956

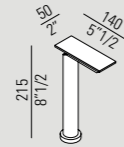

ASEN0957

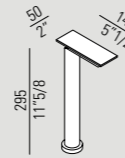

ASEN0962

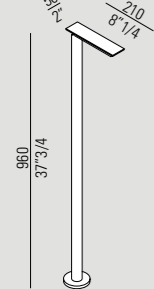

ASEN0912HS

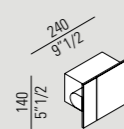

ASEN0914

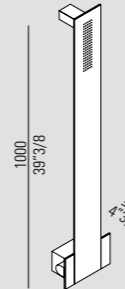

Vasca / Bathtub

ASEN0973N

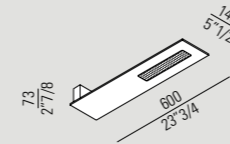

ASEN0911

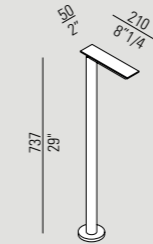

ASEN0912VS

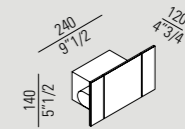

Vasca Doccia / Bathtub Shower

ASEN0913

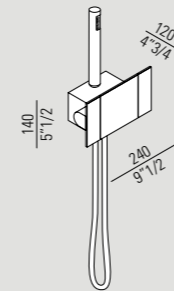

ASEN0958O

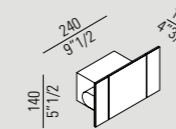

Placca per WC / Plaque for WC

ASEN0968

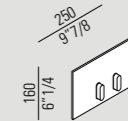

Barra per posizionamento / Bar for the positioning

AKIT680A

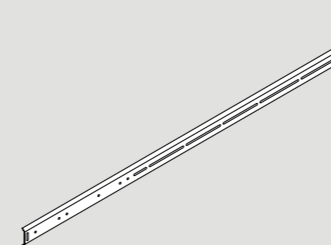

AKIT680B

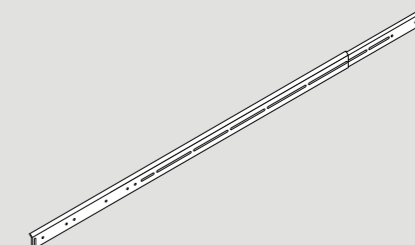

Doccia / Shower

ASEN0914

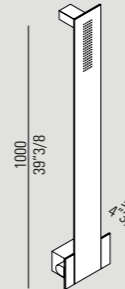

Square / 2005

Square è un progetto che cambia l'estetica della rubinetteria e la arricchisce di ulteriori funzioni, in tutte le tipologie di installazione: da incasso o esterne, per il lavabo, per la vasca o per la doccia. Square è realizzata in acciaio inox lucido o satinato.

Square is a range that changes the look of tap fittings and enhances them with additional functions, in all types of installation: recessed or surface-mounted, for washbasins, bathtubs or showers. Square is made in polished or satin-finish stainless steel.

Square, ein Design, das die Ästhetik der Armaturen abwandelt und mit weiteren Funktionen für jede Installation belegt: Unter- und Aufputz-Armaturen für Waschbecken, Badewanne und Dusche. Square ist aus glänzendem oder satiniertem Edelstahl.

Square est un projet qui modifie l'esthétique de la robinetterie et l'enrichit de fonctions supplémentaires, quels que soient les modèles choisis : encastrables ou externes, pour le lavabo, pour la baignoire ou pour la douche. Square est réalisée en acier inox poli ou satiné.

Square es un proyecto que cambia la estética de la grifería y la enriquece con otras funciones, en todos los tipos de instalación: encastrada o de superficie, para el lavabo, la bañera o la ducha. Square se fabrica en acero inoxidable brillo o satinado.



design Benedini Associati

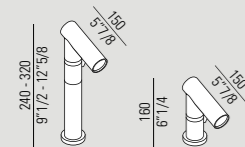

Finiture / Finishes



Spoon XL
lavabo, washbasin,
waschbecken, lavabo, lavabo
→ Tools vol. 1

369
accessori, accessories, accessoires,
accessoires, accesorios
→ Tools vol. 3

Square / 2005

Rubinetteria e dispenser per il sapone, integrati in un unico elemento dal sapore fortemente tecnologico, ma allo stesso tempo affascinante nel suo minimalismo, ammorbidito dalla nuova curvatura della bocca.

Taps and soap dispenser are integrated in a single, highly technological element which is fascinating in its minimalism, now softened by the new curved spout.

Armaturen und Seifenspender in einem gemeinsamen Element von starker Hightech-Optik, aber gleichzeitig faszinierend in seinem Minimalismus, der durch den neuen, gebogenen Auslauf gemildert wird.

Robinetteria et distributeur de savon, intégrés dans un seul élément avec une forte connotation technologique mais en même temps d'un minimalisme fascinant, adouci par la nouvelle courbe du bec.

Grifería y dispensador de jabón, integrados en un elemento único muy tecnológico pero también atractivo en su minimalismo, mitigado por la nueva curvatura de la boca.



design Benedini Associati

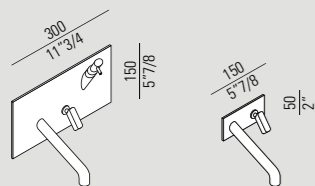

Finiture / Finishes



Square / 2005

La gamma Square è completata da gruppi composti dalla bocca di erogazione e dal comando tra loro indipendenti. Le bocche sono fornite, per collocazione su piano, in tre differenti altezze, oppure con un'unica lunghezza per posizionamento a parete, per offrire una massima versatilità.

The Square range has expanded with new units comprising a spout and a control, independent of each other. The spouts come in three different heights for top mounting or in a single length for wall mounting, to offer an absolute versatility.

Die Linie Square wird um neue Armaturen bereichert, bestehend aus voneinander unabhängigen Auslauf und Bedienhebel. Die Ausläufe sind in drei verschiedenen Höhen für Montage auf der Ablage oder in einer Länge für Wandmontage lieferbar, um maximale Flexibilität zu garantieren.

La gamme Square est complétée par groupes composés de bec de débit et de commande indépendants entre eux. Les becs sont fournis, pour montage sur plan, en trois différentes hauteurs, ou en une longueur unique pour montage mural, pour offrir un éclectisme maximal.

La gama Square se completa con grupos compuestos por la boca de distribución y el mando, independientes entre ellos. Para su colocación en la encimera, las bocas están disponibles en tres alturas diferentes o con una longitud única para instalar en la pared ofreciendo la máxima versatilidad.



design Benedini Associati

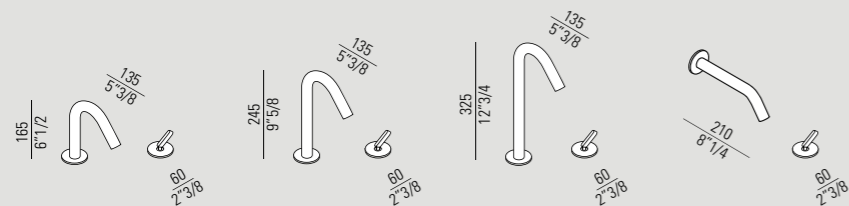

Finiture / Finishes



Square / 2005

L'estetica di Square è caratterizzata dal rigore e dalla tecnologica bellezza dell'acciaio inox, in versione satinata o lucida. Miscelatori monoforo con comando progressivo posizionabile a scelta indifferentemente a destra o a sinistra. Miscelatore e doccetta possono essere integrati in un unico elemento da terra, affiancabile a qualsiasi modello di vasca.

Square's appearance is based on clean lines, technology and the beauty of satin finish or polished stainless steel. Single-hole mixers with progressive control that can be positioned on either the right or left. Mixer tap and hand shower can be integrated in one single floor mounted element which can be used in combination with any bathtub.

Die Strenge und technologische Schönheit des Edelstahls charakterisieren die Ästhetik von Square, in satinierter und glänzender Ausführung. Einhandmischer mit progressiver Bedienung können beliebig rechts oder links angeordnet werden. Mischer und Handbrause können in einem einzigen, Standelement untergebracht werden, das für jedes Wannenmodell einsetzbar ist.

L'esthétique de Square est caractérisée par la rigueur et la beauté technologique de l'acier inox, poli ou satiné. Les mitigeurs monotrou à commande progressive peuvent être installés aussi bien à droite qu'à gauche. Le mitigeur et la douchette peuvent être intégrés dans un unique élément au sol, associable à n'importe quel modèle de baignoire.

La estética de Square se distingue por el rigor y la belleza tecnológica del acero inoxidable, en versión satinada o brillo. Mezcladores monomando con mando progresivo que pueden colocarse tanto a la derecha como a la izquierda. El mezclador y el duchador pueden integrarse en un elemento único apoyado en el suelo, que puede usarse con cualquier modelo de bañera.

Deep ○
vasca, bathtub, badewanne,
baignoire, bañera



design Benedini Associati

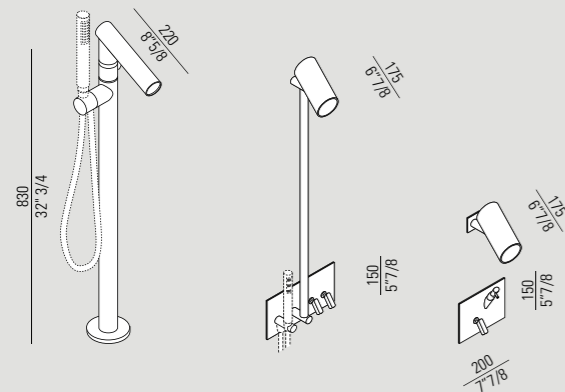

Finiture / Finishes



Square / 2005

Altre versioni per il gruppo Square per vasca con doccetta flessibile integrata: da parete oppure a bordo vasca, sempre con un design raffinatamente minimale.

Further options from the Square series for the bathtub with integrated flexible hand shower: wall- or bathtub-mounted, but always with the same sleek, minimal design.

Weitere Varianten von Wannenarmaturen Square mit integrierter Handbrause: Ob Unterputz oder am Wannenrand montiert, das Design ist stets von minimalistischer Finesse.

Autres versions pour le groupe Square pour baignoire avec douchette flexible intégrée : murale ou pour le bord de la baignoire, toujours avec un design raffiné et minimaliste.

Otras versiones del grupo Square para bañera con duchador flexible integrado: instalado a pared o sobre el borde de la bañera, siempre con un diseño refinadamente minimalista.



○
Cartesio
vasca, bathtub, badewanne,
baignoire, bañera
→ Tools vol. 2

design Benedini Associati

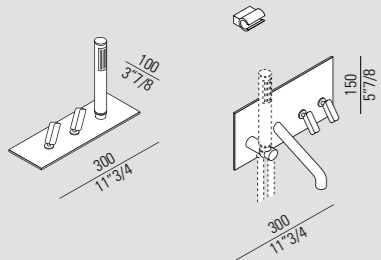

Finiture / Finishes



Square / 2005

Realizzata in acciaio inox lucido o satinato, la gamma Square è completata da un dispenser integrato per il sapone liquido e mensole da incasso.

Made in polished or satin-finish stainless steel, the Square range is completed with an integrated soap dispenser and recessed shelves.

Die Linie Square, hergestellt aus glänzendem oder satiniertem Edelstahl, wird durch einen integrierten Seifenspender und eingebaute Ablagen komplettiert.

Réalisée en acier inox poli ou satiné, la gamme Square est complétée par un distributeur intégré pour le savon liquide et par des étagères encastrables.

Fabricada en acero inoxidable brillo o satinado, la gama Square se completa con un dispensador integrado para el jabón líquido y repisas encastrables.

* con cartuccia progressiva

* with progressive cartridge

* mit progressiver Kartusche

* avec cartouche progressive

* con cartucho progresivo

Lavabo / Washbasin

ARUB0930D_ / ARUB0930C_

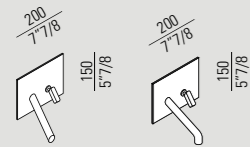

ARUB0931D_ / ARUB0931C_

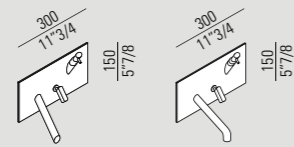

ARUB1009D_ / ARUB1009C_

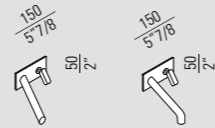

ARUB1023D_ / ARUB1023C_

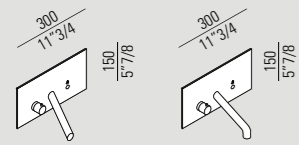

ARUB1026D_ / ARUB1026C_

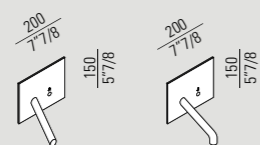

* ARUB0950_ / ARUB1021_ / ARUB0951_



ARUB1006_ / ARUB1007_ / ARUB1008_

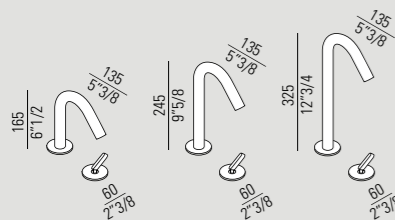

ARUB1081_

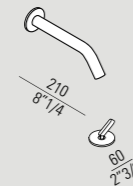

* ARUB1020_

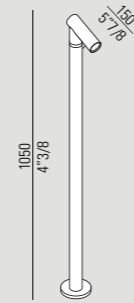

Doccia / Shower

ARUB0939N_

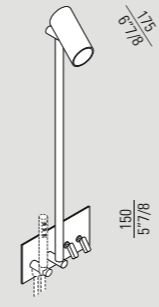

ARUB0959_

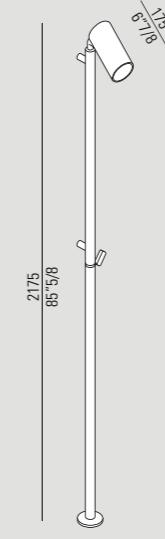

ARUB1025N_

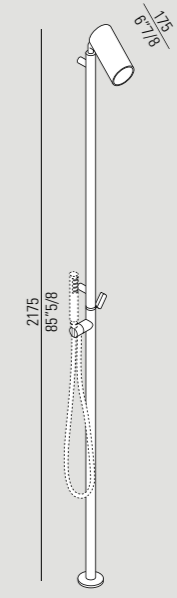

ARUB0967_

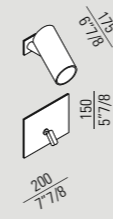

ARUB0941N_

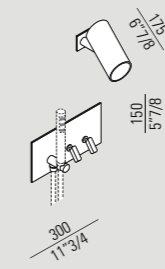

ARUB0944N_

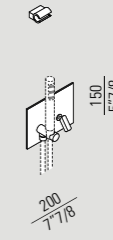

Vasca / Bathtub

ARUB0945N_

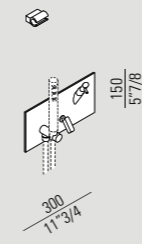

ARUB0932ND_

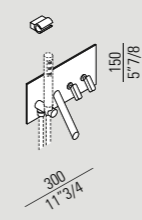

ARUB0932NC_

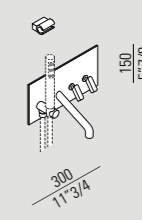

Vasca / Bathtub

ARUB0933ND_

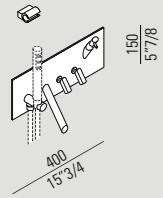

ARUB0933NC_

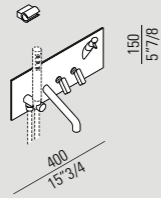

ARUB0961L_

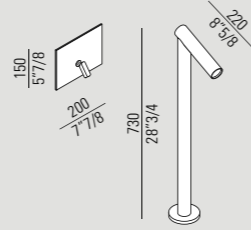

ARUB0934L_

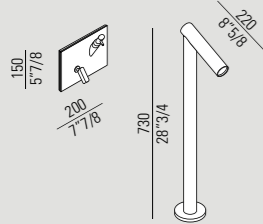

ARUB0935NL_

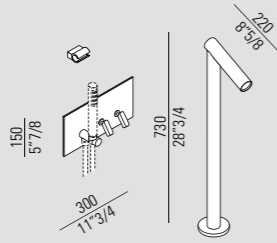

ARUB0936NL_

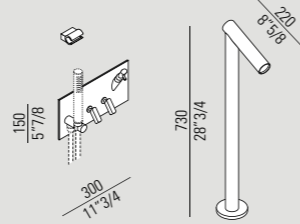

* ARUB0952L_

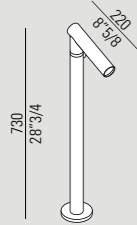

* ARUB1024N_

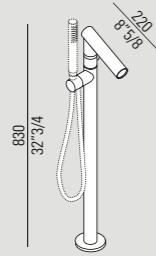

* ARUB0960_

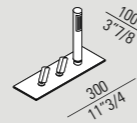

Mensole / Shelves

AMEN0946_

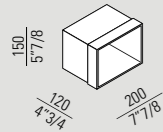

AMEN0947_

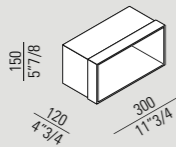

AMEN0948_

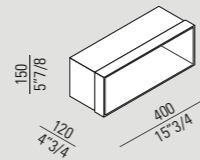

Mensole / Shelves

AMEN0949_

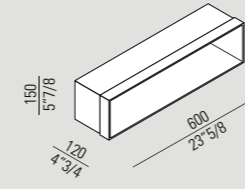

AMEN0950_

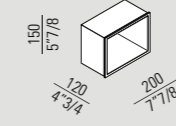

AMEN0951_

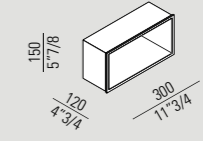

Placca per WC / Plaque for WC

AMEN0952_

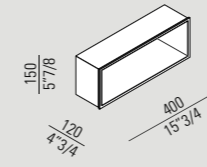

AMEN0953_

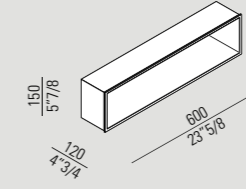

ARUB0968N_

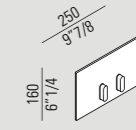

Al dente / 2003

La trasposizione di un accessorio della cucina, il colino, guida il disegno del soffione. Il diffusore dell'acqua in polipropilene arancio o verde è semplicemente appoggiato su un canestro realizzato in acciaio inox; lo stesso principio determina la forma del portasapone.

The design of the shower head is based on that of a kitchen accessory, the colander, transposed to the bathroom. The water diffuser in orange or green polypropylene simply rests on a stainless steel hoop; the same principle is used for the soap holder.

Die Abwandlung eines Küchenutensils, des Siebs, bestimmt das Design dieses Objektes. Der Brausekopf aus orangem oder grünem Polypropylen wird einfach in eine Halterung aus rostfreiem Stahl eingesetzt. Das gleiche Prinzip kommt für die Seifenschale zur Anwendung.

Transposer un accessoire de la cuisine, comme la passette, dans la salle de bains est à l'origine du design de la douche de tête. Le diffuseur de l'eau en polypropylène orange ou vert est tout simplement enfilé dans un anneau en acier inox; ce même principe est à la base de la forme du porte-savon.

El diseño de la alcachofa se basa en un accesorio usado en la cocina: el colador. El difusor del agua, fabricado en polipropileno naranja o verde, está apoyado simplemente en un cesto de acero inoxidable; el mismo diseño se ha utilizado en la jabonera.

— selezione, *selection*
Young Design, 2004

design Davide Borin, Nicola Gibertini,
Mattia Vittori

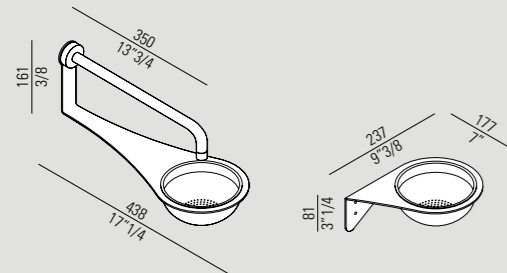

.CRUB0998AR

.CRUB0999AR

Finiture / Finishes



Fez
rubinetteria, *taps, armatur,*
robinetterie, griferia
→ Tools vol. 3



ARUB400 / 401 / 2011

Elementi che permettono di installare l'erogatore della doccia in una posizione diversa dalla presa d'acqua sul soffitto o sulla parete, ottimizzando lo spazio a disposizione.

Elements that enable you to install the shower head in a different position from the water outlet on the ceiling or wall, to make optimum use of available space.

Diese Elemente ermöglichen die Installation der Kopfbrause getrennt von der Wasserzuleitung an der Decke oder Wand, um den verfügbaren Raum optimal zu nutzen.

Éléments qui permettent d'installer la tête de la douche dans une position différente de la prise d'eau au plafond ou sur le mur, en optimisant l'espace à disposition.

Elementos que permiten instalar la alcachofa en una posición diferente respecto a la toma de agua en el techo o en la pared, optimizando el espacio.

Cooper
doccia, shower, dusche,
douche, ducha
→ Tools vol. 2



design Benedini Associati

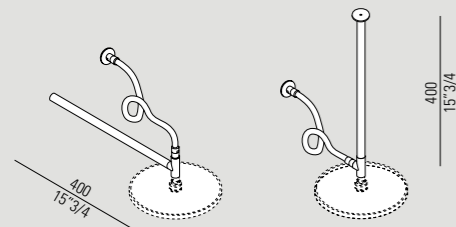

ARUB400S

ARUB401S

Hydro / 2006

Hydro offre due soluzioni: l'idroscopino® per la pulizia del WC con getto ad effetto laser, e l'idrobidet con getto morbido per l'igiene personale. La doccetta è in materiale plastico cromato o nei colori arancio o verde, il flessibile in PVC grigio e il supporto a parete in ottone cromato lucido.

Hydro offers two solutions: hydrobrush (idroscopino®) for cleaning the WC with laser effect jet, and hydrobidet with soft water gush for personal Hygiene. The hand shower is in orange, green or chrome-plated plastic, the hose is in grey PVC, and the wall bracket in polished chrome-plated brass.

Hydro gibt es für zwei Anwendungsbereiche: als „Idroscopino®“ mit laserartigem Wasserstrahl zur Toilettenreinigung und als Hydrobidet mit weichem Wasserstrahl für die persönliche Hygiene. Der Kopf ist aus verchromtem Kunststoff oder in den Farben orange oder grün, der Schlauch aus grauem PVC und die Wandhalterung aus glänzendem, verchromtem Messing.

Hydro offre deux solutions: l'idroscopino® pour le nettoyage du WC avec jet d'eau à effet laser, et hydrobidet avec jet souple pour hygiène personnelle. La douchette est en plastique chromé et existe en orange ou vert, le flexible est en PVC gris et le support mural en laiton chromé poli.

Hydro ofrece dos soluciones: la escobilla hídrica para limpiar el inodoro con un chorro muy fino de efecto láser, y el hidrobidet con chorro suave para la higiene personal. El duchador es de plástico cromado, de color naranja o verde; el flexible de PVC es gris y el soporte mural de latón cromado brillo.

design Giulio Gianurco,
UT Agape

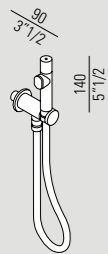

ARUB0918_

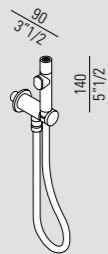

ARUB0916_

Finiture / Finishes



750
sanitari, sanitary ware,
Sanitärkeramik, sanitaires,
sanitarios

Kaa / 2003

L'elasticità della doccia e del soffione, realizzati con gomma silicónica anallergica, trasmettono la morbidezza del massaggio per la cura della persona. In arancio, danno colore alla rubinetteria della doccia.

The flexible hand shower and fixed shower head, made of hypo-allergenic silicone rubber, offer a gentle massage for the body. In orange, they bring colour to the shower fittings.

Die Elastizität von Handbrause und Brausekopf aus antiallergenem Silikongummi vermitteln dem Körper das Gefühl einer weichen Massage. In orange, verleihen sie der Duscharmatur Farbe.

L'élasticité de la douchette et de la douche de tête, réalisées en caoutchouc de silicone anallergique transmettent toute la douceur d'un massage corporel bienfaisant. En orange, ils égayent la robinetterie de la douche.

La elasticidad del duchador y de la alcachofa, realizados en goma silicónica antialérgica, transmiten toda la suavidad de un masaje. El naranja, dan color a esta grifería.

– premio, *award*
Elle Decor International
Design Awards, 2005



– premio, *award*
Design Plus Material
Vision, 2005

DESIGN PLUS

– premio, *award* German
Design, 2007



○ **Fez**
rubinetteria, taps, armatur,
robinetterie, grifería
→ Tools vol. 3

design Giulio Gianturco

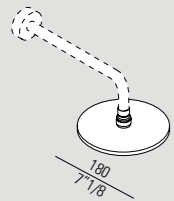

.CRUB0913AR

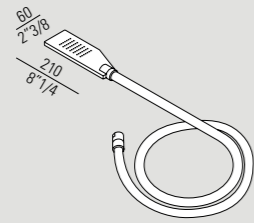

.CRUB0914AR

Finiture / Finishes



Doccette e soffioni

Soffioni, doccette e supporti in varie dimensioni da inserire nei gruppi doccia e vasca delle rubinetterie di produzione Agape.

Shower heads, hand-held showers and supports for shower and bathtub taps manufactured by Agape.

Kopfbrausen, Handbrausen und die zugehörigen Halterungen in verschiedenen Massen zur Komplettierung von Dusch- und Badewannenarmaturen unserer Produktion.

Douches de tête, douchettes et supports en différentes mesures à utiliser avec les groupes douche et baignoire des robinets de production Agape.

Alcachofas, duchadores y soportes en varias dimensiones, que completan las griferías de ducha y bañera de Agape.

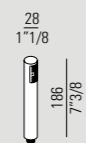
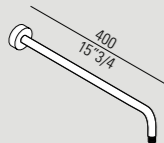

369
accessori, accessories, accessoires,
accessoires, accesorios
→ Tools vol. 3



Doccette e soffioni

Soffioni, doccette e supporti realizzati in vari materiali e finiture.

Shower heads, hand-held showers and supports in several materials and finishes.

Kopfbrausen, Handbrausen und die zugehörigen Halterungen in verschiedenen Materialien und Ausführungen.

Douches de tête, douchettes et supports réalisés en différents matériaux et finitions.

Alcachofas, duchadores y soportes realizados en varios materiales y acabados.

Soffioni / Shower heads

.MET0225R_
Ottone / Brass / Messing / Lation / Latón



.CRUB0915_
Ottone / Brass / Messing / Lation / Latón



.CRUB1100R / .CRUB1101R
ABS

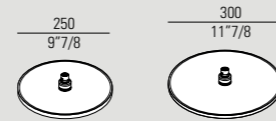

Supporti / Supports

.CRUB0903_ / .CRUB0923_
Ottone / Brass / Messing / Lation / Latón

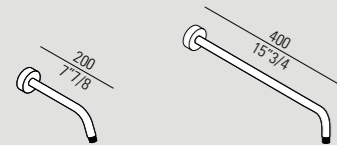

.CRUB0924_ / .CRUB0925_
Ottone / Brass / Messing / Lation / Latón

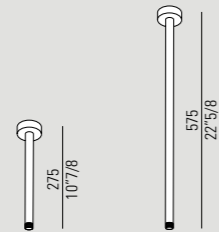

Doccette / Handheld showers

.MET0169R_
Ottone / Brass / Messing / Lation / Latón

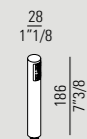

.MET0268R_
ABS

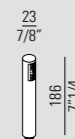

.CRUB1102R
ABS



Accanto ai protagonisti dell'ambiente bagno, anche gli accessori Agape hanno un ruolo importante: rendere la vita più bella e più comoda, grazie al loro stile ed alla loro funzionalità.

Alongside the key fixtures in the bathroom, Agape accessories have an important supporting role: to make life simpler and more pleasant with their style and functionality.

Neben den Protagonisten des Badezimmers spielen auch die Accessoires von Agape eine wichtige Rolle: das Leben schöner und bequemer zu gestalten, dank ihres Stils und ihrer Funktionalität.

Aux côtés des protagonistes de la salle de bains, les accessoires Agape jouent, eux aussi, un rôle important: rendre la vie plus belle et plus confortable, grâce à leur style et à leur fonctionnalité.

Junto a los protagonistas del cuarto de baño, también los accesorios Agape asumen una función importante: facilitar la vida y hacerla más cómoda gracias a su estilo y funcionalidad.

pag

068, 070	Bucatini
072, 074	Mach
076, 078, 080	Memory
082, 084, 086	Sen
088	Surf
090, 092	369

Agape tools 3:
Accessori/Accessories/Accessoires/Accessorios
 → pag 068.

Bucatini / 1997

Giovani e divertenti, gli accessori del programma Bucatini sono costituiti da un cavetto in acciaio inox rivestito in materiale plastico trasparente, utilizzato come portasalviette o come supporto per vaschette, contenitori, accessori e specchi.

The youthful and amusing accessories in the Bucatini range consist of a stainless steel cable sheathed in a transparent plastic material, used as a towel holder or support for trays, containers, accessories and mirrors.

Jung und lustig sind die Accessoires des Programms Bucatini, die aus einem Edelstahlseil mit transparenter Plastikhülle bestehen, das als Handtuchhalter oder Halterung für Behälter, Ablagen, Accessoires und Spiegel fungiert.

Jeunes et amusants, les accessoires du programme Bucatini sont réalisés avec un câble en acier inox revêtu d'une gaine en plastique transparent, servant de porteserviettes ou de support pour bacs, porte-objets, accessoires et miroirs.

Juveniles y divertidos, los accesorios del programa Bucatini tienen por un cable de acero inoxidable revestido con material plástico transparente: se usan como toallero o soporte para bandejas, portaobjetos, accesorios y espejos.



design Fabio Bortolani, Ermanno Righi

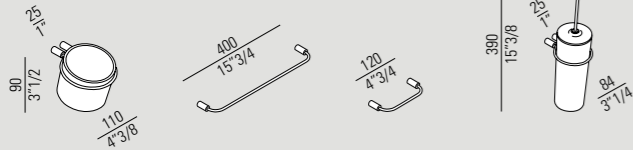

Bucatini / 1997

Accessori realizzati con un cavetto in acciaio ricoperto da materiale plastico trasparente che ha anche funzione di supporto per contenitori in ceramica bianca.

Accessories made from stainless steel cable sheathed in transparent plastic, also used as supports for white ceramic containers.

Accessoires aus einem mit transparentem PVC ummantelten Kabel, das auch als Halterung für Behälter aus weißer Keramik fungiert.

Accessoires réalisés avec un câble en acier revêtu d'une gaine en plastique transparent servant également à soutenir les objets de rangement en céramique blanche.

Accesorios realizados con un pequeño cable de acero recubierto con material plástico transparente cuya función es también la de sostener los contenedores de cerámica blanca.

Accessori / Accessoires

ABUC0160 / ABUC0160S

Porta sapone / Soap holder / Seifenschale / Porte-savon / Porta jabón

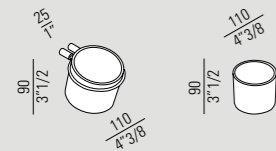

ABUC0161 / ABUC0161S

Porta spazzolini / Toothbrush holder / Zahnbürstenhalter / Porte-brosses à dents / Porta cepillos de dientes

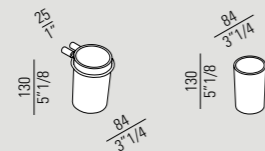

ABUC0179

Supporto per dispenser / Support for dispenser / Halterung für Seifenspender / Support pour distributeur savon liquide / Soporte para dispensador de jabón líquido



ABUC0180

Mensola / Shelf / Spiegelablage / Tablette / Repisa

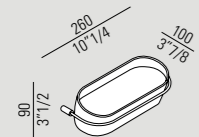

ABUC0182 / ABUC0182S

Contenitore / Container / Behälter / Récipient / Contenedor

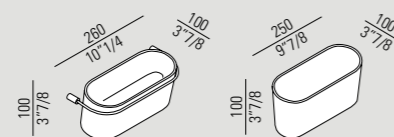

ABUC0175

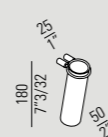

ABUC0165

Porta salviette / Towel holder / Handtuchhalter / Porte-serviettes / Toallero

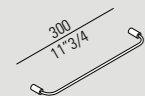

ABUC0166



ABUC0167

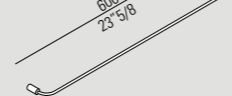

ABUC0168



ABUC0179



ABUC0171

Porta abiti / Clothes hanger / Kleiderhaken / Patères / Perchero

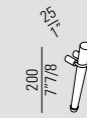

ABUC0170



ABUC0172 / ABUC0174

Porta rotolo / Toilet roll holder / Toilettenpapierhalter / Porte-rouleau papier toilette / Portarollo

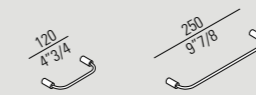

ABUC0173

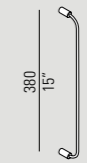

ABUC0176

Porta riviste / Magazine holder / Zeitungshalter / Porte-revues / Porta revistas

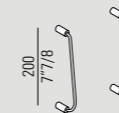

ABUC0175

Porta scopino / Toilet brush holder / Toilettenbürste / Porte-balai WC / Porta escobilla

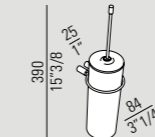

Mach /2000

Acciaio inox lucido o satinato e Solid surface bianco per Mach, il programma di accessori contraddistinto da uno stile geometrico e razionale. Nell'ideazione della serie l'attenzione è stata rivolta principalmente alle necessità funzionali degli spazi dedicati alla collettività quali ristoranti, bar e hotel ma trova una facile collocazione anche all'interno degli spazi dedicati al bagno domestico.

Polished or satin finish stainless steel and white Solid surface for Mach, a range of accessories characterised by their geometric and rational style. When creating this range, the designer concentrated mainly on the practical needs of public spaces such as restaurants, bars and hotels, but it fits equally well into the home bathroom.

Glänzender oder satiniertes Edelstahl und weißes Solid surface für Mach, das Programm der Accessoires im geometrischen und rationalen Stil. Beim Entwurf dieser Serie galt das Hauptaugenmerk den funktionellen Ansprüchen von Sanitäreinrichtungen in Restaurants, Bars und Hotels, sie kann aber ebenso gut im häuslichen Bad eingesetzt werden.

Acier inox poli ou satiné et Solid surface pour Mach, le programme d'accessoires doté d'un style géométrique et rationnel. Lors de la conception de la série, l'attention s'est portée principalement sur les nécessités fonctionnelles des espaces destinés à la collectivité, tels que les restaurants, les bars et les hôtels, mais la série trouve aussi sa place dans les salles de bains de nos maisons.

Acero inoxidable brillo o satinado y material Solid surface blanco para Mach, la serie de accesorios que se diferencia por un estilo geométrico y racional. Para diseñar esta serie, se basaron principalmente en las necesidades de espacios públicos como restaurantes, bares y hoteles, aunque ubica también idóneamente en espacios domésticos.



design Konstantin Grcic

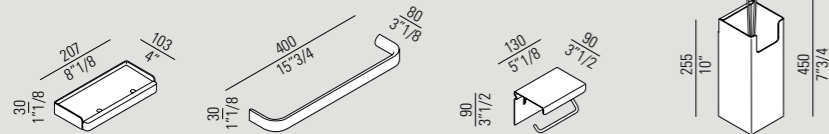

Finiture / Finishes



Mach / 2000

Accessori realizzati in acciaio inox con finitura lucida o satinata. Mensole in Solid surface bianco.

Stainless steel accessories with polished or satin finish. Shelves in white Solid surface.

Accessoires aus glänzendem oder satiniertem Edelstahl. Ablagen aus weißem Solid surface.

Accessoires en acier inox poli ou satiné. Étagères en Solid surface blanc.

Accesorios de acero inoxidable con acabado brillo o satinado. Estantes de Solid surface blanco.

Accessori / Accessoires

AMAC0654
Porta sapone / Soap holder / Seifenschale / Porte-savon / Porta jabón

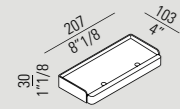

AMAC0670
Porta sapone - spazzolini / Soap - Toothbrush holder / Seifenschale Zahnbürstenhalter / Porte savon - brosses à dents / Porta jabón - cepillos de dientes

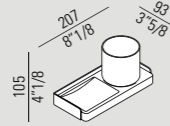

AMAC0657
Dispenser per sapone / Liquid soap dispenser / Seifenspender / Distributeur de savon liquide / Dispensador de jabón líquido

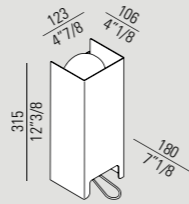

AMAC0666
Porta salviette / Towel holder / Handtuchhalter / Porte-serviettes / Toallero

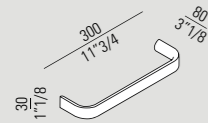

AMAC0667

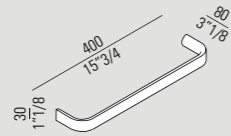

AMAC0668

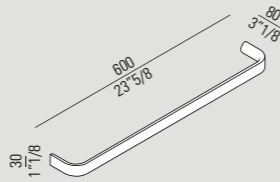

AMAC0663
Dispenser salviette / Paper towel dispenser / Papierhandtuchspender / Distributeur serviettes / Dispensador de servilletas

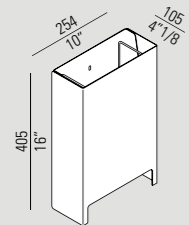

AMAC0658
Porta abiti / Clothes hanger / Kleiderhaken / Patères / Perchero



AMAC0659 / AMAC0660
Porta rotolo / Toilet roll holder / Toilettenpapierhalter / Porte-rouleau papier toilette / Portarollo

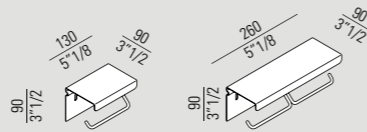

AMAC0665
Porta scopino / Toilet brush holder / Toilettenbürste / Porte-balai WC / Porta escobilla

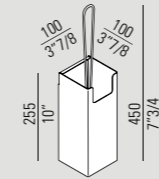

AMAC0661
Porta sacchetti igienici / Sanitary bags dispenser / Sanitärbeutelspender / Porte-sachets hygiéniques / Porta bolsas higiénicas

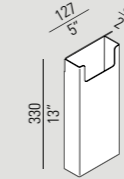

AMAC0662
Porta "kleenex" / Tissue box holder / Kleenextuchspender / Distributeur mouchoirs papier / Porta "kleenex"

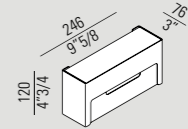

AMAC0664
Gettacarta / Wastepaper basket / Papierkorb / Corbeille à papier / Papelera

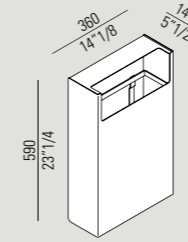

Memory / 2010

Una proposta completa di accessori per la sala da bagno, ispirati alla cultura del design del XX secolo, rivisitata alla luce della contemporaneità.

A complete range of accessories for the bathroom, inspired by Twentieth-century design culture, revisited in a contemporary light.

Eine komplette Serie von Accessoires für das Badezimmer, die sich von der Designkultur des 20. Jahrhunderts inspirieren lässt und im zeitgemäßen Stil neu interpretiert wird.

Une proposition complète d'accessoires pour la salle de bains s'inspirant de la culture du design du XXe siècle, réinterprétée dans un style plus contemporain.

Una gama completa de accesorios para el cuarto de baño, inspirados en la cultura del diseño del siglo XX, revisitada con una visión contemporánea.



design Benedini Associati

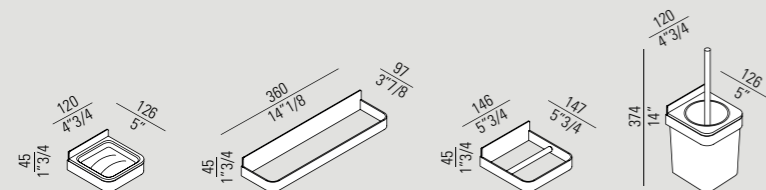

Memory / 2010 – 2012

Comodo e raffinato
scalda salviette
autoregolante,
realizzato in acciaio
cromato lucido o
verniciato in bianco o
nero. Viene fissato alla
parete con un sistema
invisibile.

An elegant and
convenient self-
regulating heated
towel rail in steel with
a polished chrome-
plated or black and
white painted finish.
It is attached to
the wall through an
invisible system.

Praktisch und raffiniert
die selbstregelnden
Handtuchtrockner,
hergestellt aus Stahl,
entweder verchromt
glänzend, oder weiß
oder schwarz lackiert.
Wird an der Wand mit
unsichtbaren Befesti-
gungselemen ten
fixiert.

Chauffe-serviettes
pratique et raffiné avec
autorégulation, réalisé
en acier chromé poli
ou laqué en blanc
et noir. Il est fixé au
mur par un système
invisible.

Toallero calentador
con autorregulación,
cómodo y refinado,
construido en acero
cromado brillo o
lacado blanco o negro.
Se fija a pared con un
sistema invisible.

300W laccato
250W cromato – 230V
IP 66 cl 2



design Benedini Associati

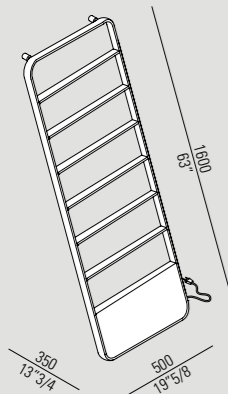

Finiture / Finishes



Memory
accessori, accessories,
accessoires, accessoires,
accesorios
→ Tools vol. 3



Memory / 2010

Accessori realizzati in acciaio inox lucido, con fissaggi non visibili, completati da elementi in Cristalplant®biobased bianco.

Polished stainless steel accessories, with hidden fixings, completed with white Cristalplant®biobased elements.

Accessoires aus glänzendem Edelstahl mit unsichtbarer Wandbefestigung, komplettiert durch Elemente aus weißem Cristalplant®biobased.

Accessoires réalisés en acier inox poli, avec fixations invisibles, dotés d'éléments en Cristalplant®biobased blanc.

Accesorios de acero inoxidable brillo, con fijaciones invisibles; se completan con elementos de Cristalplant®biobased blanco.

Accessori / Accessoires

AMEM856A
Mensola / Shelf / Spiegelablage / Tablette / Repis

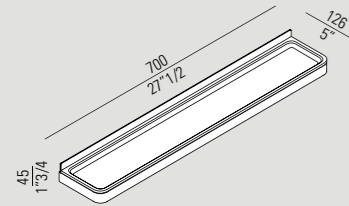

AMEM852A

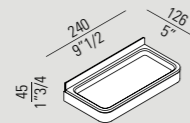

AMEM851A

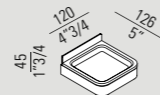

AMEM854A
Porta sapone / Soap holder / Seifenschale / Porte-savon / Porta jabón

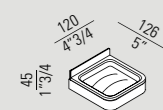

AMEM853A
Porta spazzolini / Toothbrush holder / Zahnbürstenhalter / Porte-brosses à dents / Porta cepillos de dientes

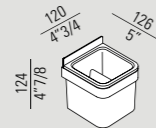

AMEM857A
Porta salviette / Towel holder / Handtuchhalter / Porte-serviettes / Toallero

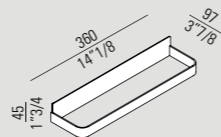

AMEM858A

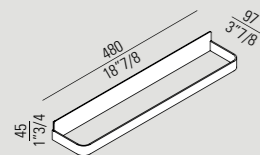

AMEM859A

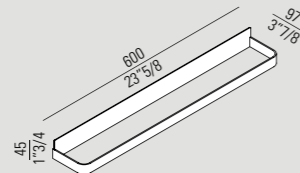

AMEM862A

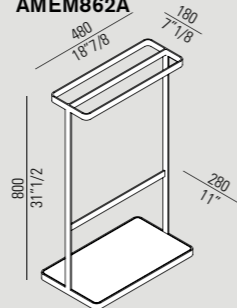

AMEM864A
Porta abiti / Clothes hanger / Kleiderhaken / Patères / Perchero



AMEM860A / AMEM861A
Porta rotolo / Toilet roll holder / Toilettenpapierhalter / Porte-rouleau papier toilette / Portarollo

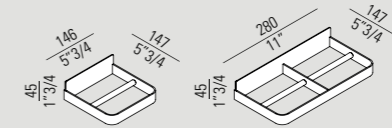

AMEM855A
Porta scopino / Toilet brush holder / Toilettenbürste / Porte-balai WC / Porta escobilla

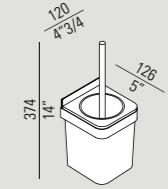

AMEM8871_
Scalda salviette / Heated towel rail / Handtuchtrockner / Chauffe serviettes / Calentador de toallas



Sen / 2008

Un programma componibile di accessori, realizzati in alluminio anodizzato spazzolato nero (grigio a richiesta), che disegnano un'unica linea essenziale nello spazio bagno. Gli accessori Sen risolvono tutte le situazioni e le funzioni dell'ambiente bagno, con uno stile ed una versatilità sorprendenti.

A modular range of accessories that create a single, essential line in the bathroom. Made from brushed anodised aluminium, available in black (grey on demand). The Sen range of accessories provides surprisingly stylish and versatile solutions to all the functions required in a bathroom.

Ein moduläres Programm von Accessoires aus schwarzem Aluminium, eloxiert und gebürstet, das eine einzige, puristische Linie in den Baderaum zaubert SerieAusführung (grau auf Anfrage). Accessoires Sen lösen alle Situationen und Funktionen im Badezimmer mit überraschendem Stil und Vielseitigkeit.

Un programme composable d'accessoires, réalisés en aluminium anodisé brossé noir (grise à la demande), qui dessinent une ligne essentielle unique dans la salle de bain. Les accessoires Sen résolvent toutes les situations et les fonctions de l'espace salle de bain, avec un style et une flexibilité surprenantes.

Un programa modular de accesorios en aluminio anodizado cepillado negro (gris bajo petición), que dibujan una única línea en el cuarto de baño. Los accesorios Sen resuelven todas las situaciones y funciones en el cuarto de baño con un estilo y versatilidad sorprendentes.

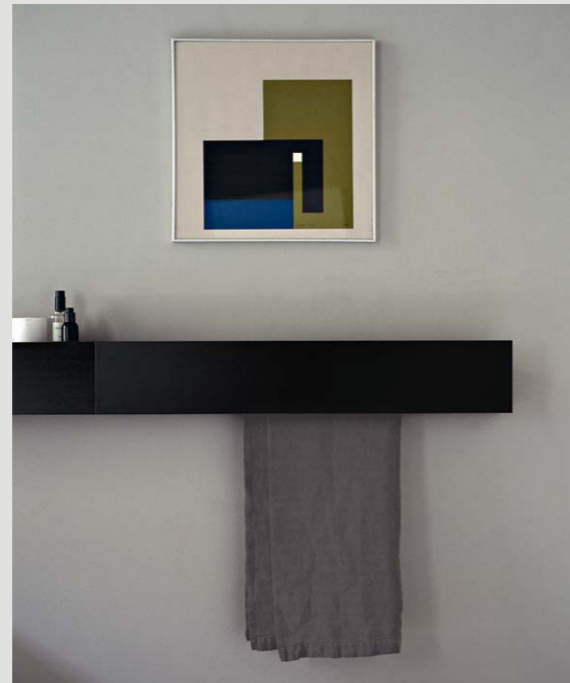

design Nicolas Gwenael, Curiosity

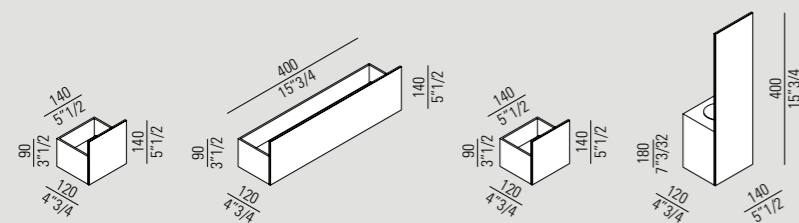

Finiture / Finishes



○ **Sen**
rubinetteria, taps, armatur,
robinetterie, griferia
→ Tools vol. 3

○ **Pear 2**
sanitari, sanitary ware,
WCs und bidets, sanitaires,
sanitarios
→ Tools vol. 1

Sen / 2008 – 2012

La collezione Sen è completata da uno scalda salviette autoregolante, sempre in alluminio spazzolato nero, in sintonia con l'ispirazione minimalista di questo progetto (grigio a richiesta).

The Sen collection is complete with a self-regulating heated towel rail, also in black brushed aluminium, to match the minimalist spirit of the entire range (grey on demand).

Die Kollektion Sen wird durch einen selbstregelnden Handtuchtrockner komplettiert, ebenfalls in Aluminium schwarz gebürstet, in Harmonie mit dem minimalistischen Design der SerieAusführung (grau auf Anfrage).

La collection Sen est complétée par un chauffe-serviettes avec autorégulation, toujours en aluminium brossé noir, en harmonie avec le style minimaliste de ce projet (grise à la demande).

La colección Sen se completa con un toallero calefactor con autorregulación, también en aluminio cepillado negro, en sintonía con la inspiración minimalista de este proyecto (gris bajo petición).

250W – 230V
IP 66 cl 2

design Nicolas Gwenaël, Curiosity

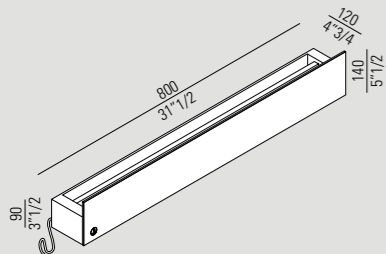

Finiture / Finishes



Sen / 2008

Accessori realizzati in alluminio anodizzato spazzolato con finitura nera abbinabile all'omonima serie di rubinetti (grigio a richiesta).

Accessories made from brushed anodised aluminium available in black, to be matched with the Sen tap range (grey on demand).

Accessoires aus eloxiertem, gebürstetem, schwarzem Aluminium, kombinierbar mit der gleichnamigen Armaturenserie Ausführung (grau auf Anfrage).

Accessoires en aluminium anodisé brossé avec finition noire assortie à la série de robinets du même nom (grise à la demande).

Accesorios de aluminio anodizado cepillado con acabado negro combinable con la grifería homónima (gris bajo petición).

Accessori / Accessoires

ASEN0915
Mensola / Shelf / Spiegelablage / Tablette / Repisa

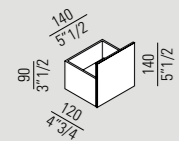

ASEN0917

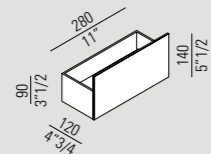

ASEN0921

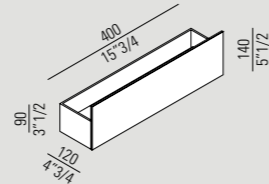

ASEN0923

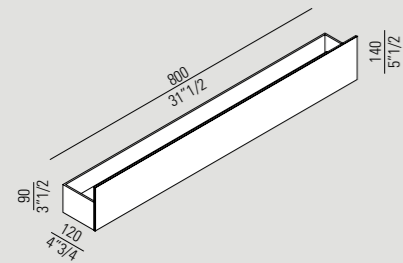

ASEN0919
Porta salviette / Towel holder / Handtuchhalter / Porte-serviettes / Toallero

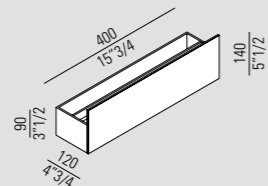

ASEN0922

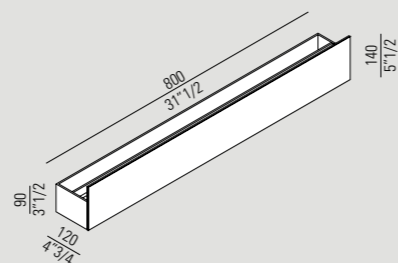

ASEN0974
Porta abiti / Clothes hanger / Kleiderhaken / Patères / Perchero

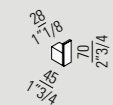

ASEN0972
Porta rotolo / Toilet roll holder / Toilettenpapierhalter / Porte-rouleau papier toilette / Portarollo

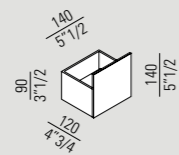

ASEN0925
Porta scopino / Toilet brush holder / Toilettenbürste / Porte-balai WC / Porta escobilla

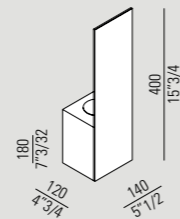

ASEN0976
Scalda salviette / Heated towel rail / Handtuchtrockner / Chauffe serviettes / Calentador de toallas

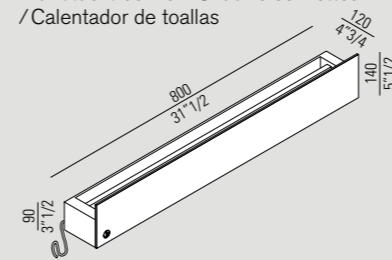

Surf / 2007

Una serie di accessori in Exmar bianco, studiati per affiancare i vassoi della zona lavabo, porgendo tutto quanto serve, con uno stile particolare: dallo spazzolino da denti, al sapone liquido, agli altri oggetti per l'igiene e la bellezza.

A range of accessories in white Exmar, designed to go with the trays in the washbasin area, stylishly keeping everything you need to hand: from toothbrush to liquid soap, as well as other toiletries and beauty products.

Eine Serie von Accessoires aus weißem Exmar, die die Waschbecken-ablagen um alles stilvoll in Reichweite zu haben: Zahnbürste, Flüssigseife und alle sonstigen Utensilien für Hygiene und Schönheitspflege.

Une série d'accessoires en Exmar blanc, pensés pour accompagner les plateaux de la zone lavabo, présentant tout le nécessaire, avec un style particulier: de la brosse à dents, au savon liquide, en passant par tous les autres objets au service de l'hygiène et de la beauté.

Una serie de accesorios en Exmar blanco, pensados para ser combinados con las bandejas de la zona lavabo, presentando todo lo necesario con un estilo particular: el cepillo de dientes, el jabón líquido y todos los objetos al servicio de la higiene personal y la belleza.



design Benedini Associati

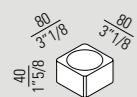

ACOM0632Z

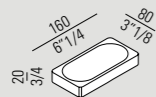

ACOM0634Z

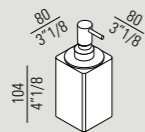

ACOM0633Z

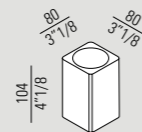

ACOM0631Z



369 / 2004

Un programma completo di accessori, progettati per soddisfare ogni possibile esigenza di installazione e d'uso, con uno stile rigorosamente contemporaneo. Gli accessori del programma 369 sono realizzati in acciaio inox lucido o satinato, con elementi in Cristalplant®biobased bianco.

A full range of accessories designed to satisfy any possible installation and use requirement, in a rigorously contemporary style. The accessories in the 369 range are made from polished or satin-finished stainless steel, with white Cristalplant®biobased elements.

Diese komplette Serie von Accessoires, rigoros im zeitgenössischen Stil, wurde entwickelt, um allen Anforderungen von Installation und Gebrauch gerecht zu werden. Die Accessoires im Programm 369 sind aus glänzendem oder satiniertem Edelstahl, mit Elementen aus weißem Cristalplant®biobased.

Un programme complet d'accessoires, conçus pour satisfaire n'importe quelle exigence d'installation et d'utilisation, avec un style rigoureusement contemporain. Les accessoires du programme 369 sont réalisés en acier inox poli ou satiné, avec éléments en Cristalplant®biobased blanc.

Un programa completo de accesorios diseñados para satisfacer todas las exigencias posibles de instalación y uso, con un estilo rigurosamente contemporáneo. Los accesorios del programa 369 se fabrican en acero inoxidable brillo o satinado, con elementos de Cristalplant®biobased blanco.



design Benedini Associati

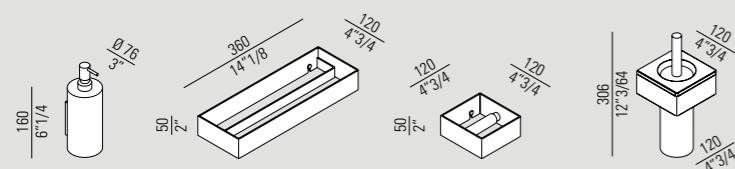

Finiture / Finishes



369 / 2004

Programma di accessori e lampade. Supporti realizzati in acciaio inox satinato o lucido, ed elementi in Cristalplant®biobased bianco.

Range of accessories and lights. Support elements in satin finish or polished stainless steel, and elements in white Cristalplant®biobased.

Serie von Accessoires und Leuchten. Grundelemente aus satiniertem oder poliertem Edelstahl und Elemente aus weißem Cristalplant®biobased.

Programme d'accessoires et d'appliques. Supports réalisés en acier inox satiné ou poli et éléments en Cristalplant®biobased blanc.

Programa de accesorios y lámparas. Soportes de acero inoxidable satinado o brillo y elementos de Cristalplant®biobased blanco.

Accessori / Accessoires

A369222 / A369200

Elemento accessoriabile / Basic support element / Grundelement / Support à compléter / Elemento a completar

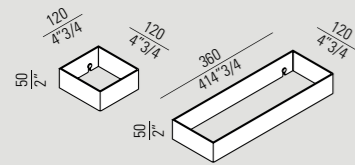

A369201 / A369202

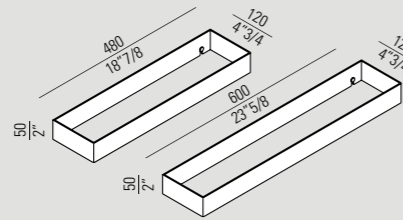

A369203

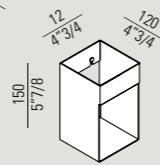

A369204

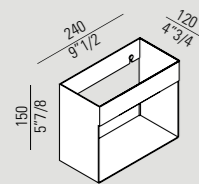

A369205

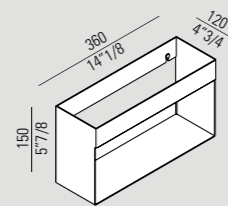

A369206

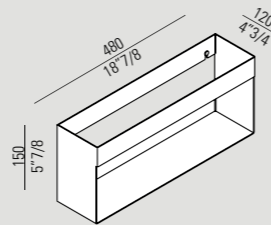

A369207 / A369208

Porta salviette / Towel holder / Handtuchhalter / Porte-serviettes / Toallero

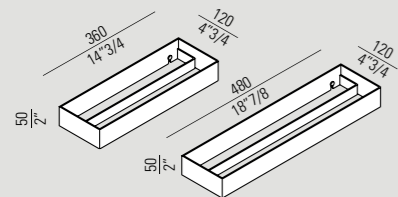

A369209

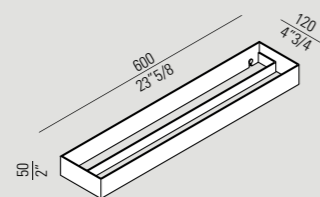

A369210Z

Mensola / Shelf / Spiegelablage / Tablette / Repisa

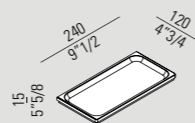

A369211Z / A369212Z

Porta sapone / Soap holder / Seifenschale / Porte-savon / Porta jabón

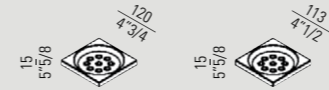

A369228Z / A369224

Dispenser per sapone / Liquid soap dispenser / Seifenspender / Distributeur de savon liquide / Dispensador de jabón líquido

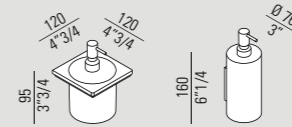

A369213Z

Porta spazzolini / Toothbrush holder / Zahnbürstenhalter / Porte-brosses à dents / Porta cepillos de dientes

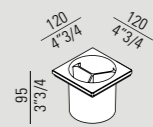

A369223

Porta abiti / Clothes hanger / Kleiderhaken / Patères / Perchero

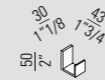

A369214 / A369219

Porta rotolo / Toilet roll holder / Toilettenpapierhalter / Porte-rouleau papier toilette / Portarollo

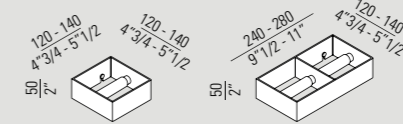

A369218

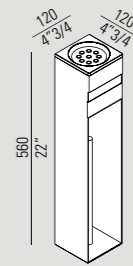

A369215

Porta scopino / Toilet brush holder / Toilettenbürste / Porte-balai WC / Porta escobilla

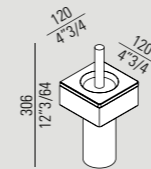

A369216

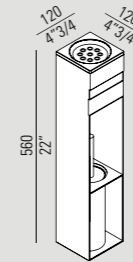

A369217

Gettacarta / Wastepaper basket / Papierkorb / Corbeille à papier / Papelera

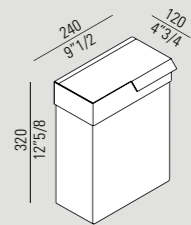

A369227

Lampada / Lampada / Wandleuchte / Applique / Lámpara

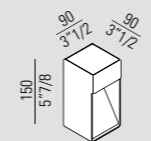

A369226

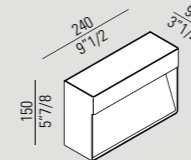

A369225

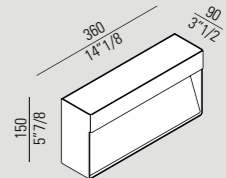

Idee divertenti e funzionali, sorprendenti e comode, capaci di andare oltre le solite convenzioni e di esprimere un concetto evoluto di stanza da bagno: tutto questo è Agape, nelle grandi come nelle piccole soluzioni.

Fun and functional ideas, surprising and convenient, capable of going beyond the usual conventions and expressing an advanced concept of bathroom design: all this is Agape, in both large and small solutions.

Amüsante und funktionale Ideen, überraschend und bequem, die über die gewohnten Konventionen hinausgehen und ein entwickeltes Konzept von Badezimmer zum Ausdruck bringen: all das ist Agape, sowohl im Kleinen als auch im Großen.

Des idées amusantes et fonctionnelles, surprenantes et pratiques, capables d'aller au-delà des conventions habituelles et d'exprimer un concept moderne de salle de bains: c'est l'essence même d'Agape, présente aussi bien dans les petites que dans les grandes solutions.

Ideas divertidas y funcionales, sorprendentes y cómodas, capaces de superar las convenciones habituales y expresar un concepto evolucionado de cuarto de baño: todo esto es Agape, en las soluciones grandes y en las pequeñas.

pag

096	Basket
098	Midi Basket
100	Multifunzione
102	Pic-nic
104	Roto
106	Stairs
108	Surf
110	Tapiro
112	Ted
114	X

Agape tools 3:
Complementi / Extras /
Zubehör / Complé-
ments / Complemen-
tos → pag 096.

Basket / 1992

Capiente contenitore di forma cilindrica in multistrato curvato, disponibile con finitura in rovere naturale, bruno, scuro, in teak oppure nei colori bianco o grigio. Il contenitore Basket è utilizzabile anche come seduta. I fori sui lati permettono di spostarlo agevolmente, anche senza aprire il coperchio.

A roomy, cylindrical-shaped container. Made of curved plywood and available in a natural, brown or dark oak finish, in teak or in a white or grey colour. The Basket container can also be used as a seat. Holes in the sides make it easy to move it around without any need to open the lid.

Geräumiger Behälter in Zylinderform. Aus gebogenem Schichtholz in den Ausführungen Eiche natur, braun, dunkel oder Teak, außerdem in weiß oder grau. Der Behälter Basket kann auch als Hocker verwendet werden. Die Grifflöcher auf den Seiten lassen ihn leicht verschieben, auch ohne den Deckel zu öffnen.

Grand coffre cylindrique en multiplis cintré, disponible dans la finition chêne naturel, brun, foncé, en teck ou dans les coloris blanc ou gris. Le coffre Basket peut servir de tabouret. Les trous latéraux permettent de le déplacer facilement sans devoir ouvrir le couvercle.

Contenedor espacioso, cilíndrico fabricado en contrachapado curvo, disponible con acabado roble natural, marrón, oscuro, de teca o lacado blanco y gris. El contenedor Basket se puede utilizar como taburete. Puede moverse fácilmente gracias a sus huecos laterales, incluso sin abrir la tapa.



design Benedini Associati

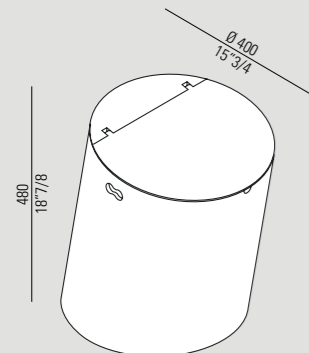

ACOM0510_

Finiture / Finishes

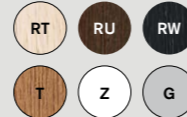

Midi Basket / 1996

Questo elegante gettacarte può essere installato a parete o appoggiato sul pavimento. Realizzato in multistrato curvato, con finitura in rovere naturale, bruno, scuro, in teak o nei colori bianco o grigio.

This elegant wastepaper basket can be wall mounted or floor standing. Made of curved plywood, with a natural, brown or dark oak finish, in teak or in a white or grey colour.

Dieser elegante Papierkorb kann wandhängend montiert oder auf den Boden gestellt werden. Aus gebogenem Schichtholz in den Ausführungen Eiche natur, braun, dunkel oder Teak, außerdem in weiß oder grau.

Cet élégant panier-poubelle peut être fixé au mur ou posé au sol. Il est réalisé en multiplis cintré, disponible dans la finition chêne naturel, brun, foncé, en teck ou dans les coloris blanc ou gris.

Esta elegante papelera puede fijarse a pared o apoyarse en el suelo. Fabricada en contrachapado curvo, con acabado roble natural, marrón, oscuro, de teca o lacada en blanco o gris.

design Benedini Associati

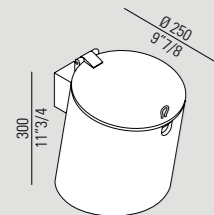

ACOM0601_

Finiture / Finishes

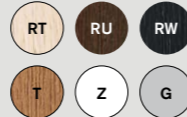

Multifunzione / 2009

Tutto realizzato in Exmar bianco, è un comodo accessorio portaoggetti e portasalviette, da affiancare alla vasca o al lavabo.

Completely made from white Exmar, this is a useful towel holder and shelf, to be placed near a bathtub or washbasin.

Ganz aus Exmar ist dieses praktische Accessoire zur Aufnahme von Utensilien und Handtüchern, das neben Wanne oder Waschtisch gestellt werden kann.

Entièrement réalisé en Exmar blanc, c'est un accessoire astucieux porte-objets et porte-serviettes, à placer près de la baignoire ou du lavabo.

Completamente fabricado en Exmar blanco, es un cómodo accesorio portaobjetos y toallero, para colocar cerca de la bañera o del lavabo.

design Benedini Associati

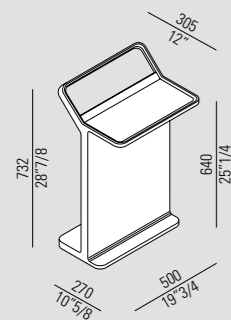

ACOM0509Z



Cartesio
vasca, bathub, badewanne,
baignoire, bañera
→ Tools vol. 2



Pic-nic / 1993

Pratico porta salviette pieghevole disponibile con finitura rovere naturale, bruno, scuro, tinto teak, oppure nei colori bianco o grigio.

A practical folding towel holder in a natural, brown or dark oak finish, painted teak or in a white or grey colour.

Praktischer, zusammenklappbarer Handtuchhalter in den Ausführungen Eiche natur, braun, dunkel oder Teak gefärbt, außerdem in weiß oder grau.

Porte-serviettes pliant disponible dans la finition chêne naturel, brun, foncé, teint en teck ou dans les coloris blanc ou gris.

Práctico toallero plegable, disponible con acabado roble natural, marrón, oscuro o barnizado color teca, o también lacado en blanco o gris.



design Benedini Associati

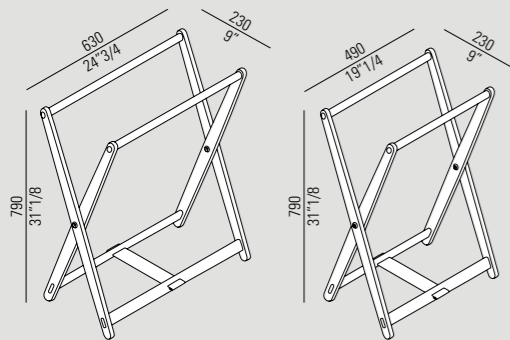

ACOM0530_

ACOM0530_S

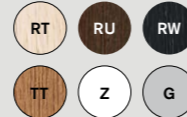
Finiture / Finishes

Roto / 2006

I contenitori Roto ampliano la gamma degli omonimi lavabi e sono caratterizzati dal medesimo design sinuoso. Utilizzabili anche come seduta, nei più diversi spazi della casa. Disponibili nei colori laccati bianco, arancio, verde e grigio.

Roto storage units complement the range of washbasins that go by the same name and feature the same curvy design. They can also be used as a seat in many different places around the house. Available in lacquered white, orange, green and grey.

Die Behälter Roto ergänzen die gleichnamigen Waschbecken und zeichnen sich durch das gleiche geschwungene Design aus. Auch als Hocker in jedem anderen Raum der Wohnung verwendbar. Erhältlich in weiß, orange, grün und grau lackiert.

Ces articles de rangement Roto complètent la gamme des lavabos portant le même nom et sont caractérisés par le même design sinueux. Il peuvent aussi être utilisés comme siège et placés partout dans la maison. Disponibles dans les couleurs laquées blanc, orange, vert et gris.

Los contenedores Roto amplían la gama de los lavabos de la misma serie y se caracterizan por un diseño igualmente sinuoso. Se pueden usar también como taburete, en cualquier espacio de la casa. Disponibles en colores lacados blanco, naranja, verde y gris.



design Maurizio Negri, Benedini Associati

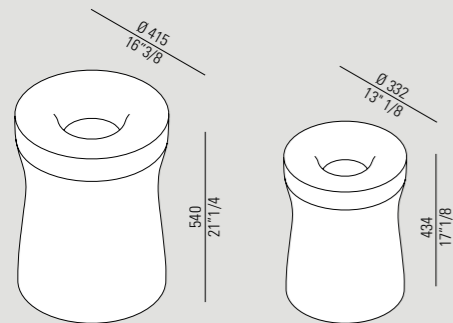

ACOM0792_

ACOM0791_

Finiture / Finishes



Stairs / 1996

I complementi Stairs risolvono le esigenze più diverse, con un'estrema semplicità. Si appoggiano alla parete e possono dare vita a molteplici soluzioni, a partire da tre elementi, in versione singola o per composizioni multiple: portasalviette, portasalviette con ripiani o elementi con 5 ripiani. Disponibili in rovere naturale, bruno, scuro, o tinto teak oppure in bianco o grigio laccati.

The Stairs complements respond to the most different demands with extreme simplicity. They rest against the wall and allow multiple solutions, starting from 3 Elements, single or in different combinations: towel rail, towel rail with shelves or element with 5 shelves. Available in natural, brown, dark oak or teak or white or grey painted.

Die Elemente der Serie Stairs erfüllen die verschiedensten Bedürfnisse mit extremer Einfachheit. Sie lehnen an der Wand und ermöglichen eine Vielzahl von Lösungen, ausgehend von drei Elementen, einzeln oder in verschiedenen Kombinationen: Handtuchhalter, Handtuchhalter mit Ablagen oder Element mit 5 Ablagen. Lieferbar in Eiche natur, braun, dunkel oder teak oder weiß oder grau lackiert.

Les compléments Stairs résolvent plusieurs et différentes exigences, avec une simplicité extrême. En appui au mur ils peuvent engendrer plusieurs solutions, à partir de trois éléments, en version simple ou pour compositions multiples: porte serviette, porte serviette avec étagères ou éléments avec 5 étagères. Disponibles en chêne naturel, brun, foncé, ou teak ou en blanc ou gris laqués.

Les compléments Stairs résolvent plusieurs et différentes exigences, avec une simplicité extrême. En appui au mur ils peuvent engendrer plusieurs solutions, à partir de trois éléments, en version simple ou pour compositions multiples: porte serviette, porte serviette avec étagères ou éléments avec 5 étagères. Disponibles en chêne naturel, brun, foncé, ou teak ou en blanc ou gris laqués.



design Benedini Associati

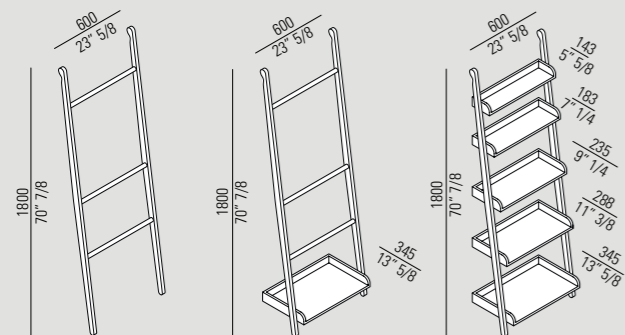

Finiture / Finishes

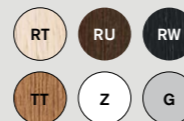

Surf / 2006

I vassoi Surf possono essere collocati liberamente sui piani d'appoggio, risolvendo con immediatezza ogni necessità. Disponibili in tre misure, tutti con conca portasapone, sono realizzati in Solid surface bianco. Surf può essere posizionato in appoggio sui bordi dei lavabi Agape Woodline, 002 o 003 risolvendo in modo semplice la disposizione degli oggetti utilizzati.

Surf trays can be freely placed on countertops, offering an immediate answer to all storage needs. Available in three sizes, all with soap dish, they are made in white Solid surface. Surf can be placed on the edges of Agape Woodline, 002 or 003 washbasins, providing a simple way to keep frequently-used objects to hand.

Die Ablagen Surf können beliebig auf horizontale Oberflächen gestellt werden. Lieferbar in drei Maßen, alle mit Seifenablage, aus weißem Solid surface. Surf kann auf die Ränder der Agape Waschbecken Woodline 002 oder 003 gelegt werden und bietet somit Ablagefläche für häufig verwendete Gegenstände.

Les plateaux Surf peuvent être posés librement sur les plans d'appui et satisfaire ainsi les moindres exigences. Disponibles en trois dimensions et tous munis d'un porte-savon modelé dans la tablette, ils sont réalisés en Solid surface blanc. Surf peut être posé sur les bords des lavabos Agape Woodline, 002 ou 003 pour disposer aisément les accessoires utilisés.

Las bandejas Surf son de libre disposición sobre encimeras, resolviendo inmediatamente cualquier necesidad. Disponibles en tres medidas, todos con jabonera, están fabricadas en Solid surface blanco. Surf puede apoyarse sobre los lavabos Agape Woodline, 002 o 003 y solucionar con sencillez la disposición de los objetos utilizados.

Fez

rubinetteria, taps, armatur,
robinetterie, grifería
→ Tools vol. 3

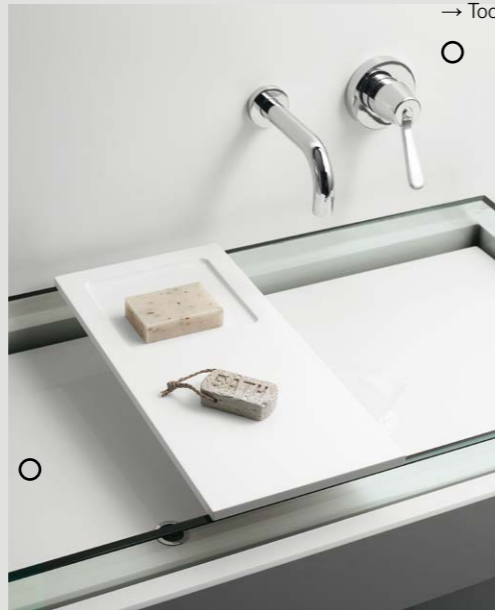

003
lavabo, washbasin,
waschbecken, lavabo,
lavabo

design Benedini Associati

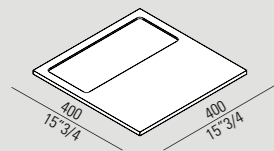

ACOM0626Z

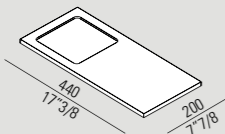

ACOM0625Z

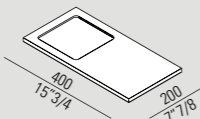

ACOM0627Z



Tapiro / 1992

Un tappeto per il bagno di ispirazione etnica, realizzato con bacchette tonde in rovere naturale, bruno, scuro, o in teak connesse con lacci di cuoio.

A bath mat with an ethnic feel, made of round rods in natural, brown or dark oak or in teak held together by leather thongs.

Ein ethnisch angehauchter Badezimmerteppich aus Rundstäben in Eiche natur, braun, dunkel, oder in Teak, die durch Lederbänder verbunden werden.

Un tapis pour la salle de bains d'inspiration ethnique, réalisé avec des baguettes arrondies en chêne naturel, brun, foncé, ou en teck retenues par des lacets en cuir.

Una alfombrilla para el baño de inspiración étnica, realizada con varillas redondas de roble natural, marrón, oscuro o de teca, unidas con cordones de cuero.

design Alessandro Farnetti

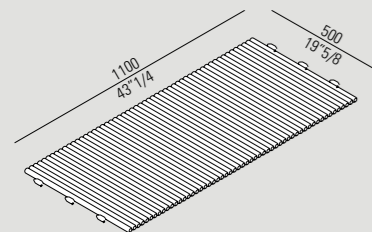

AKAR0524L_

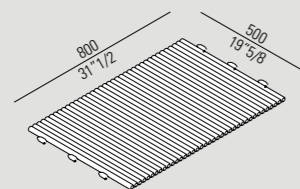

AKAR0524_

Finiture / Finishes



Ted /2014

Un pratico strumento per l'organizzazione dell'ambiente bagno sempre a portata di mano.

Accessorio da terra regolabile in altezza con porta oggetti, porta salviette e porta rotolo in acciaio inox lucido con base e ripiano in Solid surface bianco, da affiancare a mobili, lavabo, vasca o sanitari.

A practical tool for the organization of the bathroom, always at hand. Freestanding and adjustable in height, with shelf, towel rack and toilet roll holder in polished stainless steel with basis and shelf in white Solid surface, to complement washbasins, bathtub or sanitary ware.

Ein praktisches Instrument für die Organisation des Badezimmers, immer zur Hand. Freistehend, höhenverstellbar, mit Ablage, Handtuchhalter und Toilettenpapierhalter aus glänzendem Edelstahl; Fuß und Ablage aus weißem Solid surface. Zur Ergänzung von Waschbecken, Badewanne oder Sanitärkeramik.

Un instrument pratique pour l'organisation de la salle de bain toujours à portée de main. Il s'agit d'un accessoire au sol en acier inox poli avec base et étagère réglable en hauteur en Solid Surface blanc, doté de porte-objets et porte rouleau en acier poli avec base et étagère en Solid surface blanc, à utiliser à côté de meubles, lavabos, baignoires ou sanitaires.

Un instrumento práctico para la organización del ambiente baño, siempre a mano. Accesorio a pie regulable en altura con porta objetos, toallero y sostenedor de papel higiénico en acero inox brillante con base y repisa en Solid surface blanco, para colocar junto a muebles, lavabos, bañera o water.

design Daniele Dalla Pellegrina

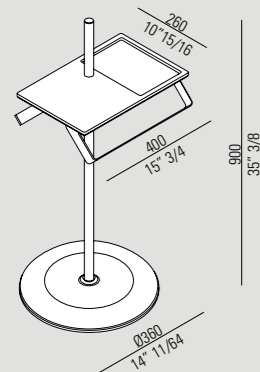

ACOM0514Z



X / 2012

Un comodo e versatile accessorio realizzato in legno con finitura rovere naturale, bruno, scuro o tinto teak. La struttura, alta o bassa, può essere accessorizzata con il vassoio, utilizzabile come tavolino o portaoggetti. Senza vassoio la struttura alta è un pratico porta salviette mentre la struttura bassa diventa anche sgabello con la seduta in cuoio naturale o nero.

A handy, versatile wooden accessory in a natural, brown or dark oak finish or painted teak. The tall or short structure can be accessorised with a tray to create a handy table or portable storage shelf. Without the tray, the tall structure becomes a handy towel rack, while the shorter version can also become a stool, with a black or tan leather seat.

Ein bequemes, vielseitiges Element aus Holz im Dekor Eiche natur, braun, dunkel oder Teak gefärbt. Das Gestell, hoch oder niedrig, wird mit einem Tablett zum kleinen Tisch oder zur nützlichen Ablage. Ohne Tablett ergibt das hohe Gestell einen praktischen Handtuchhalter, das niedrige Gestell mit dem Sitz aus Leder natur oder schwarz einen praktischen Hocker.

Un accessoire commode et polyvalent, réalisé en bois dans la finition chêne naturel, brun, foncé ou teint en teck. La structure, haute ou basse, peut être complétée par le plateau, utilisable comme petite table ou porte-objets. Sans plateau, la structure haute est un porte-serviettes tandis que la structure basse elle devient tabouret avec une assise en cuir naturel ou noir.

Un accesorio cómodo y versátil realizado en madera, con acabado roble natural, marrón, oscuro o barnizado color teca. La estructura, alta o baja, puede incorporar distintos accesorios como la bandeja, usada como mesa o portaobjetos. Sin la bandeja, la estructura alta es un práctico toallero mientras que la estructura baja se transforma en una banqueta con asiento de cuero natural o negro.



Vieques
vasca, bathtub, badewanne,
baignoire, bañera
→ Tools vol. 2

design Benedini Associati

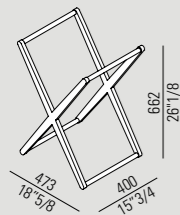

ACOM0539_

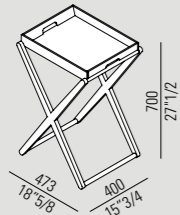

ACOM0622_

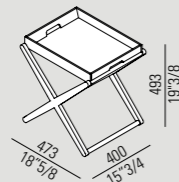

ACOM0623_

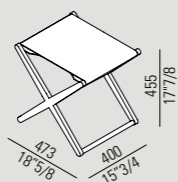

ACOM0538_

Finiture / Finishes

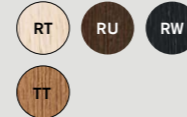

369
accessori, accessories,
accessoires, accessoires,
accesorios
→ Tools vol. 3

Square
rubinetteria, taps, armatur,
robinetterie, griferia
→ Tools vol. 3



In-Out
vasca, bathtub,
badewanne, baignoire,
bañera
→ Tools vol. 2

Agape info:
Rubinetti/Taps/Armaturen/Robinetterie/Grifería
 → pag 117, **Accessori/Accessories/Accessoires/Accessoires/Accesorios** → pag 118, **Complementi/Extras**
/Zubehör/Compléments/Complementos → pag 118.

+

Glossario materiali/Glossary of materials/
Glossar Materialien/Glossaire des matériaux
/Glosario de materiales → pag 120.

Rubinetti/Taps

Fez
 design Benedini Associati
 → 006, 007, 008, 009, 010, 011, 012, 013, 014, 015, 016, 017, 018, 019

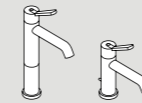

Fez
 design Benedini Associati



Fez
 design Benedini Associati

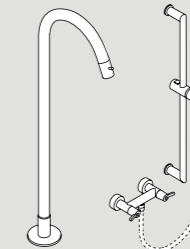

Memory
 design Benedini Associati
 → 020, 021, 022, 023, 024, 025, 026, 027

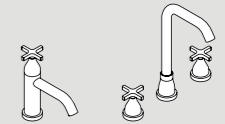

Memory
 design Benedini Associati

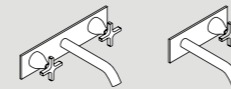

Memory
 design Benedini Associati

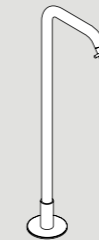

Sen
 design Nicolas Gwenaël
 Curiosity → 028, 029, 030, 031, 032, 033, 034, 035, 036, 037, 038, 039

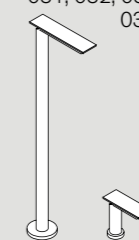

Sen
 design Nicolas Gwenaël
 Curiosity

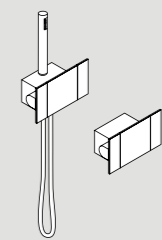

Sen
 design Nicolas Gwenaël
 Curiosity



Square
 design Benedini Associati
 → 040, 041, 042, 043, 044, 045, 46, 047, 048, 049, 050, 051, 052, 053

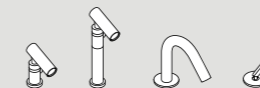

Square
 design Benedini Associati

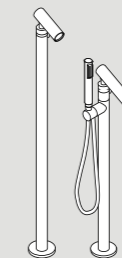

Square
 design Benedini Associati

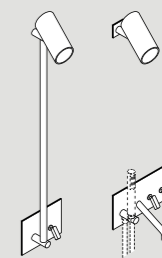

Square
 design Benedini Associati

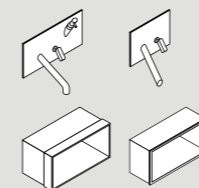

Rubinetteria/ Tapware extras

Al dente
 Davide Borin, Nicola Gibertini,
 Mattia Vittori
 → 054, 055

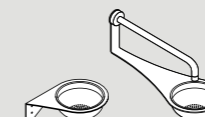

ARUB400/401
 design Benedini Associati
 → 056, 057

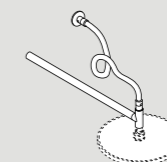

Hydro
 design Giulio Gianurco,
 UT Agape
 → 058, 059

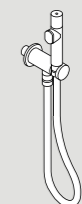

Kaa
design Giulio Gianurco
→ 060, 061

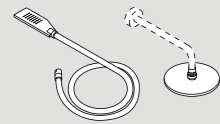

Doccette e soffioni
→ 062, 063, 064, 065

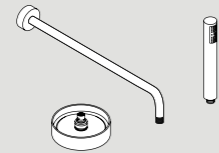

Accessori / Accessoires

Bucatini
design Fabio Bortolani,
Ermanno Righi
→ 068, 069, 070, 071

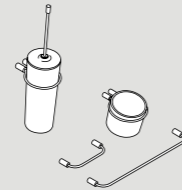

Mach
design Konstantin Grcic
→ 072, 073, 074, 075

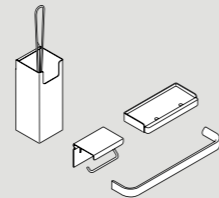

Memory
design Benedini Associati
→ 076, 077, 078, 079, 080,
081

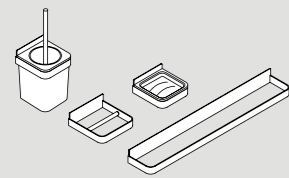

Sen
design Nicolas Gwenael,
Curiosity
→ 082, 083, 084, 085, 086,
087

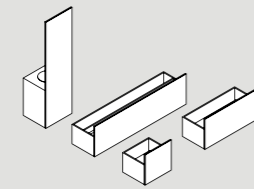

Surf
design Benedini Associati
→ 088, 089

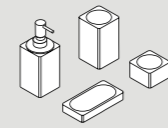

369
design Benedini Associati
→ 090, 091, 092, 093

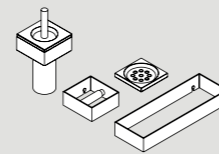

Complementi / Extras

Basket
design Benedini Associati
→ 096, 097

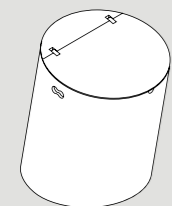

Midi Basket
design Benedini Associati
→ 098, 099



Multifunzione
design Benedini Associati
→ 100, 101

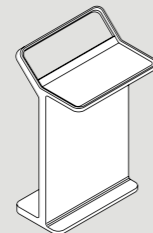

Pic-nic
design Benedini Associati
→ 102, 103

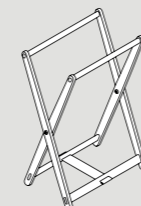

Roto
design Maurizio Negri,
Benedini Associati
→ 104, 105

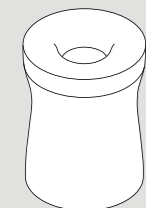

Stairs
design Benedini Associati
→ 106, 107

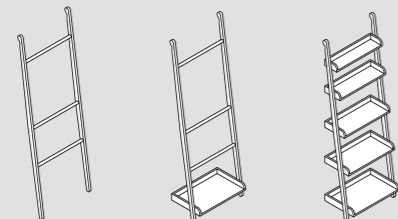

Surf
design Benedini Associati
→ 108, 109

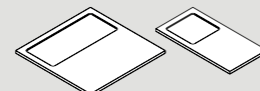

Tapiro
design Alessandro Farnetti
→ 110, 111

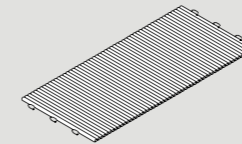

Ted
design Daniele Dalla Pellegrina
→ 112, 113

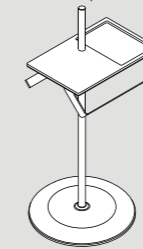

X
design Benedini Associati
→ 114, 115

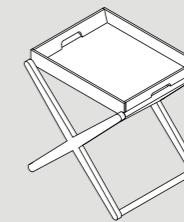

Glossario materiali

1) Legno

Il patrimonio tecnologico della cantieristica navale è un dato fondamentale nella progettazione di elementi in legno per il bagno. L'invecchiamento esalta le naturali doti estetiche del legno aumentando le prestazioni tecnologiche. Esteticamente ciò che più affascina del legno è il suo ciclo di vita, l'aspetto cangiante legato al passare del tempo e delle stagioni misurato attraverso il lento mutare della superficie, delle venature e del colore.

2) Cristalplant®biobased

Cristalplant®biobased è un materiale eco-sostenibile derivante da materie prime resinose di origine vegetale miscelate a materiali inerti naturali di estrema purezza. La superficie, con effetto "soft-touch" ha un aspetto simile alla pietra naturale che lo rende particolarmente indicato per l'utilizzo nell'ambiente bagno. Il materiale è omogeneo in tutto il suo spessore e può facilmente essere ripristinato.



3) Exmar

Materiale ottenuto dalla composizione di resina e polvere di quarzo. La superficie, con finitura satinata bianca, è setosa, calda e piacevole al tatto. L'applicazione dell'Exmar nella realizzazione di vasche da bagno è ideale poiché il materiale possiede la capacità di trattenere a lungo il calore dell'acqua.

4) Solid surface

Materiale compatto e non poroso, composto in modo omogeneo da 1/3 di resina acrilica e da 2/3 di idrossido di alluminio, un minerale naturale con il quale molte persone si trovano quotidianamente a contatto, poiché costituisce, ad esempio, un componente importante dei dentifrici. Completamente atossico e riciclabile. La superficie si presenta omogenea, setosa al tatto, durevole e facile da pulire.

5) Ceramilux®

Materiale composito realizzato con cariche minerali naturali (carbonati di calcio e idrati di alluminio) miscelate a resina poliestere; rivestimento con gelcoat a base poliestere isoneopentilica. Ceramilux® è un

materiale non assorbente, resistente agli sbalzi di temperatura, ai graffi e all'abrasione.

6) Parapan®

Prodotto a base acrilica, Parapan® si presenta come un materiale monolitico, lucido, massiccio e uniformemente colorato. Materiale ecologico, privo di solventi, riciclabile al 100%, inalterabile nel tempo, i colori risultano resistenti ai raggi UV. La base acrilica, rende il Parapan® impermeabile, facilmente manutenibile e particolarmente adatto nell'impiego in ambienti umidi come il bagno.

7) Polietilene

Il Polietilene appartiene alla famiglia dei polimeri derivati dal monomero etilene. È la materia plastica più comune e trova larghissimo impiego. La possibilità di modellazione plastica dell'oggetto, la colorazione, l'intervento sulla texture, la leggerezza, nonché la riciclabilità, fanno del polietilene un materiale adatto alle applicazioni della produzione Agape.

8) Exacril

Exacril è un metacrilato di rivestimento con superficie lucida (100 gloss a specchio) nato come alternativo al laccato lucido. Il forte spessore, 1,4 mm, consente incollaggi anche sui bordi con difettosità infinitesimali e lo rende ripristinabile ad eventuali graffi. La superficie lucida è resistente nel tempo, non perde brillantezza e non si deforma, resiste al calore, è impermeabile e non assorbente. È un prodotto atossico ed ecologico.

9) Gomma siliconica

La gomma siliconica è un polimero elastomero contenente atomi di silicio e di ossigeno. Il composto è stabile ed irreversibile, le proprietà meccaniche ed elastiche del materiale non subiscono variazioni in intervalli di temperature elevate. Le caratteristiche peculiari della gomma siliconica sono la morbidezza, la totale atossicità e la colorazione pura; qualità che permettono un'applicazione ideale laddove il materiale entra a contatto diretto con il corpo e con l'acqua. La flessibilità permette di rimuovere facilmente il calcare che si deposita durante l'utilizzo del prodotto.

10) Ceramica

Impasto di sostanze argillose a struttura compatta modellato e quindi consolidato mediante processi di cottura che ne

garantiscono i processi di vetrificazione della superficie, di notevole resistenza meccanica ed elettrica.

11) Marmo

Roccia calcarea cristallizzata e compatta. La produzione Agape utilizza attualmente marmo bianco di Carrara con finitura satinata. I lavabi sono realizzati con lastre unite tramite incollaggio o scavati direttamente su blocco.

12) Acciaio Inox

Il termine acciaio inossidabile (o inox) indica genericamente gli acciai ad alta lega contenenti cromo ed altri leganti che aumentano la resistenza alla corrosione. Materiale con doti di resistenza, durezza ed elasticità molto maggiori di quelle del ferro semplice. I prodotti Agape in acciaio inox subiscono trattamenti superficiali di lucidatura o di satinatura.

13) Alluminio

L'alluminio è un metallo morbido e leggero con un colore argenteo vivo, dovuto ad uno strato sottile di ossidazione che si forma rapidamente quando è esposto all'aria. È estremamente resistente alla corrosione atmosferica: per tale ragione non richiede nessuna verniciatura di protezione, ma può essere ugualmente trattato con un'ampia gamma di rivestimenti, dalle verniciature alle anodizzazioni colorate. L'alluminio è non magnetico, non tossico e non infiammabile.

14) Ottone

Col nome di ottone si indica una lega di rame e zinco, compresa nella più ampia famiglia del bronzo. È un metallo molto utile, grazie alla sua resistenza e lavorabilità. I prodotti Agape in ottone subiscono trattamenti superficiali di cromatura lucida o di cromatura satinata.

15) Cristallo

Costituito essenzialmente da silicati è ottenuto per fusione di sabbia silicea con ossidi e carbonati. Grazie alla perfetta trasparenza, all'inalterabilità e alla capacità di reagire alla luce in forma mutevole, il cristallo trova particolare applicazione negli accostamenti con gli altri materiali che compongono la produzione Agape. Le giunzioni tra le parti sono realizzate con speciali collanti che garantiscono la perfetta trasparenza e continuità del materiale.

Glossary of materials

1) Wood

The technological know-how gained in the ship-building industry is an essential factor when designing wooden components for the bathroom. Ageing enhances the natural appearance of wood, increasing its technological performance. Aesthetically, the most fascinating thing about wood is its life cycle, its changing appearance as time and seasons go by, evidenced by slow alteration of the surface, grain and colour.

2) Cristalplant®biobased

Cristalplant®biobased is an environmentally safe material deriving from resinous raw materials of plant origin mixed with natural aggregates of extreme purity. The "soft touch" surface looks like natural stone, which makes it particularly suitable for use in the bathroom. The material has a uniform structure throughout and can easily be touched up to restore the original finish.



3) Exmar

A composite material formed by a mix of resin and quartz powders. Its white, satin-finish surface is silky, warm and pleasant to the touch. It is ideal for use in the production of bathtubs as it is able to retain the heat of the water for a long time.

4) Solid surface

A compact, non-porous material which is a homogeneous mix of 1/3 resin and 2/3 aluminium hydroxide, a natural mineral with which many people are in daily contact as it constitutes, for example, an important ingredient of toothpaste. Completely non-toxic and recyclable. The surface is smooth, silky to the touch, durable and easy to clean.

5) Ceramilux®

Composite material made with natural mineral content (calcium carbonates and aluminium hydrates) mixed with polyester resins; coated with polyester-based iso-neopentyl gelcoat. Ceramilux® is a non absorbent material, resistant to changes in temperature, scratches and abrasion.

6) Parapan®

An acrylic based product, Parapan® is a glossy, solid, monolithic material

that is coloured throughout. It is environmentally-friendly, solvent-free, 100% recyclable, extremely durable and its colouring is UV resistant. The acrylic base makes Parapan® waterproof, easy to maintain and particularly suitable for use in most environments, such as the bathroom.

7) Polyethylene

Polyethylene is part of the family of polymers deriving from the monomer ethylene. It is the most common plastic material and is widely used. The possibilities for moulding, colouring and texturing objects, its lightness and its recyclability make polyethylene an ideal material for Agape products.

8) Exacril

Exacril is a methacrylate used to give a glossy coating (100 gloss units), developed as an alternative to high-gloss paint finishes. Its 1.4 mm thickness means it can bond even edges with minor defects, and any scratches can be repaired. Its glossy surface is long-lasting, retains its original brightness and does not deform; it is heat resistant, waterproof and non-absorbent. A non-toxic and ecological product.

9) Silicone rubber

Silicone rubber is an elastomer polymer containing atoms of silicone and oxygen. The compound is stable and irreversible and its mechanical and elastic properties are not subject to alteration at higher temperatures. The specific characteristics of silicone rubber are softness, total non-toxicity and purity of colour. These qualities make it ideal for use where the material comes into direct contact with the body and water. Its flexibility allows easy removal of any lime scale deposited during use of the product.

10) Ceramic

A mixture of clayey substances with a compact structure that is moulded and then hardened by firing, which causes the surface to vitrify and acquire great mechanical and electrical resistance.

11) Marble

Marble is a compact, crystallized, calcareous rock. Agape currently uses white Carrara marble with satin-finish for its products. Washbasins are made from slabs joined together by gluing or carved directly out of the block.

12) Stainless steel

Stainless steel is the generic term for high alloy steels containing chromium and other alloying elements that increase resistance to corrosion. A material that is much stronger, harder and more resilient than plain iron. Agape stainless steel products are surface-treated to give a polished or satin finish.

13) Aluminium

Aluminium is a soft, light metal, with a bright silver colour due to the thin oxide layer which quickly forms when it is exposed to the air. It is extremely resistant to atmospheric corrosion and therefore does not require any protective varnish, although it can take a wide range of finishes, from varnish coating to coloured anodising treatments. Aluminium is neither magnetic, nor toxic, nor flammable.

14) Brass

Brass is an alloy of copper and zinc and forms part of the wider bronze family. It is a very useful metal because it is tough yet easy to work. Agape brass products are chromium-plated with a polished or satin finish.

15) Crystal glass

Consisting mainly of silicates, it is obtained by fusing siliceous sand with oxides and carbonates. Because of its perfect transparency, inalterability and its ability to react to light in different ways, crystal glass is particularly suitable for juxtaposition with the other materials used by Agape for its product ranges. Parts are joined using special adhesives that ensure perfect transparency and continuity of the material.

Glossar der Materialien

1) Holz

Das technologische Erbe des Schiffbaus ist beim Entwurf von Elementen aus Holz für das Bad fundamental. Der Alterungsprozess hebt die natürlichen ästhetischen Qualitäten des Holzes hervor und verbessert seine technologischen Eigenschaften. Was ästhetisch am meisten am Holz fasziniert ist sein Lebenszyklus, sein wechselndes Aussehen, das dem Verlauf der Zeit unterliegt und sich anhand des langsamen Wandlungsprozesses der Oberfläche, der Maserung und der Farbe ablesen läßt.

2) **Cristalplant®biobased**
Cristalplant®biobased ist ein ökologisch nachhaltiges Material. Es wird aus harzhaltigen Rohstoffen pflanzlicher Herkunft gewonnen, die mit natürlichen Zuschlägen von extremer Reinheit vermischt werden. Die Oberfläche mit "soft touch" Effekt sieht ähnlich wie Naturstein aus und findet daher im Badezimmer die ideale Verwendung. Das Material ist durchgehend homogen, wodurch Beschädigungen leicht behaarbar sind.



3) **Exmar**
Mischung aus Kunstharz und Quarzmehl. Die Oberfläche ist weißer, satiniertes Aussehen ist seidig, warm und angenehm anzufassen. Die Verwendung von Exmar für die Herstellung von Badewannen ist ideal, da das Material die Fähigkeit besitzt, die Wärme des Wassers langfristig zu speichern.

4) **Solid surface**
Kompaktes und nicht poröses Material, bestehend aus 1/3 Acrylharz und 2/3 Aluminiumhydroxid, einem natürlichen Material, mit dem viele Personen täglich in Kontakt kommen, da es zum Beispiel eine wichtige Komponente der Zahncreme darstellt.

5) **Ceramilux®**
Verbundmaterial aus natürlichen Mineralien (Kalziumkarbonate und Aluminiumhydrate) und Polyesterharz; mit gelcoat-Überzug auf der Basis von Iso-Neopentyl-Polyester. Ceramilux® ist ein nicht poröses Material, resistent gegenüber Temperaturschwankungen, Kratzer und Abreibung.

6) **Parapan®**
Parapan®, ein Produkt auf akrylischer Basis, präsentiert sich als monolithisches, glänzendes, massives und einheitlich durchgefärbtes Material. Ökologisch, frei von Lösungsmitteln, 100% recyclefähig, zeitbeständig, mit UV-resistenten Farben. Dank seiner akrylischen Basis ist Parapan® wasserfest, leicht instandzuhalten und besonders geeignet für die Verwendung in feuchten Ambienten wie das Bad.

7) **Polyäthylen**
Polyäthylen gehört zur Familie der vom Monomer Äthylen abgeleiteten Polymere. Es ist das verbreitetste

plastische Material mit vielfältigen Verwendungsmöglichkeiten. Die Möglichkeit zur plastischen Modellierung des Objektes, seine Farbbarkeit, die Möglichkeit der Oberflächengestaltung, seine Leichtigkeit und nicht zuletzt seine Recyclefähigkeit machen Polyäthylen zu einem für die Anwendungen der Agape-Produktion geeigneten Material.

8) **Exacril**
Exacril ist ein zur Beschichtung verwendetes Metacrylat mit glänzender Oberfläche (100 Spiegelgloss), als Alternative zum Hochglanzlack entwickelt. Seine große Stärke von 1,4 mm erlaubt Verklebungen auch der Kanten von größter Haltbarkeit und ermöglicht das Ausbessern eventueller Kratzer. Die glänzende Oberfläche ist zeitbeständig, behält ihre Brillanz und verformt sich nicht, ist hitzeresistent, wasserdicht und nicht absorbierend. Ein ungiftiges und ökologisches Produkt.

9) **Silikongummi**
Silikongummi ist ein Polymer-Elastomer, welches Silikon- und Sauerstoffatome enthält. Die Mischung ist stabil und irreversibel, die mechanischen und elastischen Eigenschaften des Materials bleiben in großen Temperaturintervallen unverändert. Besondere Charakteristika des Silikongummis sind seine Weichheit, seine absolute Ungiftigkeit und homogene Farbgebung. Qualitäten die ideal für Anwendungsbereiche sind, bei denen das Material in direkten Kontakt mit dem Körper und Wasser kommt. Dank seiner Flexibilität lassen sich entstehende Kalkablagerungen leicht entfernen.

10) **Keramik**
Masse aus tonhaltigen Substanzen mit kompakter Struktur, die modelliert und danach durch Brennprozesse gehärtet wird, die die Verglasungsprozesse der Oberfläche garantieren; von beachtlicher mechanischer und elektrischer Widerstandsfähigkeit.

11) **Marmor**
Kristallisiertes und kompaktes Kalkgestein. Die Agape-Produktion verwendet z.Zt. weißen Carraramarmor in satiniertes Aussehen. Die Waschbecken werden aus miteinander verklebten Platten hergestellt oder direkt aus dem Block gehauen.

12) **Edelstahl**
Der Begriff rostfreier Stahl (oder Inox bzw. Edelstahl) bezeichnet allgemein die Stähle mit hohem Legierungsanteil, die Chrom und andere Legierungselemente enthalten, die ihre Widerstandsfähigkeit gegen Korrosion erhöhen. Material von weitaus größerer Resistenz, Härte und Elastizität als einfaches Eisen. Die Oberflächen der Agape-Produkte aus Edelstahl werden poliert oder satiniert.

13) **Aluminium**
Aluminium ist ein weiches, leichtes Metall von silbergrauer Farbe durch die Oxidschicht, die sich im Kontakt mit Luft sehr schnell bildet. Es ist überaus witterungsbeständig und benötigt daher keinen Schutzanstrich, kann aber dennoch unterschiedlichsten Veredelungsprozessen der Oberfläche unterzogen werden, wie Lackierungen oder Eloxal-Verfahren mit Farben. Aluminium ist nicht magnetisch, nicht toxisch und nicht entflammbar.

14) **Messing**
Der Name Messing bezeichnet eine Legierung aus Kupfer und Zink, die zur Familie der Bronzen gehört. Dank seiner Widerstandsfähigkeit und Bearbeitbarkeit ein sehr nützliches Metall. Die Oberflächen der Agape-Produkte aus Messing werden glänzend oder satiniert verchromt.

15) **Kristallglas**
Hauptsächlich aus Silikaten bestehend, hergestellt durch das Schmelzen von Silikatsand mit Oxyden und Carbonaten. Dank seiner perfekten Transparenz, der Unveränderlichkeit und der Kapazität auf veränderliche Weise auf Lichteinflüsse zu reagieren, findet Kristallglas besonders Anwendung in Verbindung mit den anderen Materialien, die für die Agape-Produkte verwendet werden. Die Verbindung zwischen den Einzelteilen werden mit Spezialklebern realisiert, die die perfekte Transparenz des Materials nicht beeinflussen.

Glossaire des matériaux

1) **Bois**
Le patrimoine technologique de l'industrie navale est d'importance primordiale pour la conception d'éléments en bois destinés à la salle de bain. Le vieillissement exalte les qualités esthétiques du bois tout en augmentant ses prestations

technologiques. Du point de vue esthétique, les aspects les plus fascinants du bois sont liés à son cycle de vie, à son aspect qui change au fil du temps et des saisons et qu'on peut percevoir à travers la transformation lente de sa surface, de ses veines et de sa couleur.

2) **Cristalplant®biobased**
Cristalplant®biobased est un matériau écodurable issu de matières premières résineuses d'origine végétale mélangées à des matériaux inertes naturels extrêmement purs. La surface, avec effet « soft touch » a un aspect semblable à la pierre naturelle qui le rend particulièrement adapté à la salle de bain. Le matériau est homogène dans la masse et peut être facilement réparé.



3) **Exmar**
Résultat de la composition de résine et de poudre de quartz. Sa surface à finition satinée blanche est soyeuse, chaude et agréable au toucher. L'Exmar utilisé dans la production de baignoires est idéal puisqu'il a la capacité de garder longtemps la chaleur de l'eau.

4) **Solid Surface**
Matériau massif et non poreux, combinant de façon homogène 1/3 de résine acrylique et 2/3 d'hydroxyde d'aluminium, un minéral naturel courant dans la vie quotidienne puisqu'il s'agit, par exemple, d'un des composants essentiels des dentifrices. Complètement atoxique et recyclable. Sa surface est homogène, soyeuse au toucher, durable et facile à entretenir.

5) **Ceramilux®**
Matériau composite réalisé avec des charges minérales naturelles (carbonates de calcium et hydrates d'aluminium) mélangées à la résine polyester; revêtement avec gelcoat à base de polyester isonéopentylque. Ceramilux® est un matériau non-absorbant, résistant aux écarts de température, aux éraflures et à l'abrasion.

6) **Parapan®**
Produit à base acrylique, Parapan® est un matériau monolithique, brillant, massif et coloré de façon uniforme. Matériau écologique, sans solvants,

recyclable à 100%, et inaltérable au fil du temps, il est caractérisé par une tenue des couleurs qui résistent aux UV. Grâce à sa base acrylique, Parapan® est imperméable, facile à entretenir et particulièrement adapté à une utilisation en milieu humide comme la salle de bains.

7) **Polyéthylène**
Le polyéthylène appartient à la famille des polymères dérivés du monomère éthylène. C'est le plastique le plus commun et le plus répandu. La faculté de modeler l'objet, la coloration, la possibilité d'intervenir sur la texture, la légèreté ainsi que la recyclabilité font du polyéthylène un matériau qui s'adapte parfaitement aux applications de la production Agape.

8) **Exacril**
Exacril est un méthacrylate de revêtement avec surface brillante (100 gloss à miroir) né comme alternative au laqué brillant. La grande épaisseur, 1,4 mm, permet encollages même sur les chants avec défauts infinitésimaux et le fait restaurable à possibles éraflures. La surface brillante est résistante dans le temps, elle ne perd pas de brillant et elle ne se déforme pas, elle résiste à la chaleur, est imperméable et elle ne absorbe pas. Il est un produit atoxique et écologique.

9) **Caoutchouc de silicone**
Le caoutchouc de silicone est un polymère élastomère contenant des atomes de silicium et d'oxygène. Ce composé est stable et irréversible, ses propriétés mécaniques et élastiques ne subissent aucun changement, même en présence de variations de températures élevées. Les caractéristiques principales du caoutchouc de silicone sont la souplesse, la complète atoxicité et la coloration pure: des qualités idéales pour réaliser des produits entrant en contact direct avec le corps et l'eau. Sa flexibilité permet d'éliminer facilement le calcaire qui se dépose à l'usage.

10) **Céramique**
Pâte à base de substances argileuses à structure compacte, modelée et consolidée à travers des processus de cuisson qui garantissent la vitrification de sa surface; elle est dotée d'une résistance mécanique et électrique considérable.

11) **Marbre**
Roche calcaire cristallisée et compacte. Agape utilise actuellement le marbre blanc de Carrare à finition satinée. Les lavabos sont réalisés avec des plaques unies par collage ou bien sont creusés directement dans le bloc.

12) **Acier inox**
Le terme acier inoxydable (ou inox) indique généralement les aciers fortement alliés contenant du chrome et d'autres liants qui augmentent la résistance à la corrosion. L'acier inox est doté de qualités comme la résistance, la dureté et l'élasticité supérieures à celles du fer simple. Les produits Agape en acier inox sont soumis à des traitements superficiels de polissage ou de satinage.

13) **Aluminium**
L'aluminium est un métal malléable et léger de couleur argent vif, due à une fine couche d'oxydation qui se forme rapidement quand il est exposé à l'air. Il est extrêmement résistant à la corrosion atmosphérique : c'est la raison pour laquelle il n'a pas besoin de peinture de protection, mais peut être traité avec une ample gamme de revêtements, des peintures aux anodisations colorées. L'aluminium est amagnétique, non toxique et ininflammable.

14) **Laiton**
Le terme laiton indique un alliage de cuivre et de zinc appartenant à la grande famille du bronze. C'est un métal très utile compte tenu de sa résistance et de son usinabilité. Les produits Agape en acier inox sont soumis à des traitements superficiels de chromage poli ou de chromage satiné.

15) **Cristal**
Composé essentiellement de silicates, le cristal est le résultat de la fusion de sable de silice combiné avec des oxydes et des carbonates. Grâce à sa transparence parfaite, à son inaltérabilité et à sa capacité de réagir à la lumière de façon changeante, le cristal se combine parfaitement avec les autres matériaux utilisés dans la fabrication des produits Agape. Les jonctions entre les différentes pièces sont effectuées avec des colles spéciales qui garantissent une transparence hors pair et une continuité impeccable du matériau.

Glosario de materiales

1) Madera

El patrimonio tecnológico de la industria naval es un elemento fundamental en el proyecto de componentes de madera para el baño. El envejecimiento exalta las cualidades estéticas naturales de la madera y aumenta las prestaciones tecnológicas. Del punto de vista estético, lo que más gusta de la madera es su ciclo de vida, el aspecto cambiante que adquiere con el tiempo y las estaciones, observado a través de la lenta transformación de las superficies, de los veteados y del color.

2) Cristalplant®biobased

Cristalplant®biobased es un material ecosostenible que deriva de materias primas resinosas de origen vegetal, mezcladas con materiales inertes naturales de absoluta pureza. La superficie, suave al tacto, presenta un aspecto similar al de la piedra natural que la hace particularmente indicada para usar en el cuarto de baño. El espesor del material es homogéneo y es muy sencillo mantenerlo siempre como nuevo.



3) Exmar

Material obtenido de la composición de resina y polvo de cuarzo. La superficie, de acabado satinado blanco, es sedosa, cálida y agradable al tacto. El Exmar es ideal para la fabricación de bañeras gracias a su capacidad de conservar el calor del agua por más tiempo.

4) Solid surface

Material compacto y no poroso, compuesto en modo homogéneo por un tercio de resina acrílica y dos tercios de hidróxido de aluminio, un mineral natural con el que muchas personas entran en contacto diariamente, ya que constituye, por ejemplo, un componente importante de las pastas dentífricas. Completamente atóxico y reciclable. La superficie se presenta homogénea, sedosa al tacto, duradera y fácil de limpiar.

5) Ceramilux®

Material compuesto por cargas minerales naturales (carbonatos de calcio e hidratos de aluminio) mezcladas con resina poliéster, recubierto con gelcoat a base de

poliéster iso/neopentil. Ceramilux® es un material no absorbente, resistente a los cambios térmicos, a las rayaduras y a la abrasión.

6) Parapan®

Producto de base acrílica, el Parapan® se presenta como un material monolítico, brillante, macizo y de color uniforme. Material ecológico, sin solventes, reciclable al 100%, inalterable en el tiempo, los colores resultan resistentes a los rayos UV. Gracias a su base acrílica, el Parapan® es impermeable, fácil de mantener y particularmente idóneo para su uso en ambientes húmedos como el cuarto de baño.

7) Polietileno

El Polietileno forma parte de la familia de los polímeros derivados del monómero de etileno. Es la materia plástica más común y de amplia difusión. La posibilidad de modelado plástico del objeto, la coloración, la intervención en la textura, la ligereza, así como su facilidad de reciclaje, hacen del polietileno un material apto para fabricar los productos Agape.

8) Exacril

Exacril es un metacrilato de revestimiento con superficie brillante (100 gloss efecto espejo) que se ha creado como alternativa al lacado brillo. El gran espesor, 1,4 mm, hace que pueda pegarse también a los bordes con defectos infinitesimales y restaurarse en caso de rayaduras ocasionales. La superficie es duradera, no pierde brillo y no se deforma, resiste al calor, es impermeable y no es porosa. Es un producto atóxico y ecológico.

9) Goma silicónica

La goma silicónica es un polímero elastómero que contiene átomos de silicio y de oxígeno. El compuesto es estable e indeformable, las propiedades mecánicas y elásticas del material no sufren variaciones frente a intervalos de temperaturas elevadas. Las características peculiares de la goma silicónica son la suavidad, la completa atoxicidad y la coloración pura; estas cualidades favorecen una aplicación ideal allí donde el material entra a contacto directo con el cuerpo y con el agua. La flexibilidad permite eliminar fácilmente las sustancias calcáreas que se depositan durante

el uso del producto.

10) Cerámica

Pasta de sustancias arcillosas de estructura compacta, modelada y consolidada por medio de procesos de cocción que garantizan los tratamientos de vitrificación de la superficie, de notable resistencia mecánica y eléctrica.

11) Mármol

Roca calcárea cristalizada y compacta. En la actualidad, Agape utiliza mármol blanco de Carrara con acabado satinado. Los lavabos se fabrican con planchas unidas mediante encolado o esculpidos en un bloque.

12) Acero inoxidable

El término acero inoxidable (o inox), por lo general, describe los aceros de alta aleación que contienen cromo y otros aglomerantes que aumentan la resistencia a la corrosión. Material con cualidades de resistencia, dureza y elasticidad muy superiores respecto al hierro simple. Los productos Agape en acero inoxidable son sometidos a tratamientos superficiales de pulido o satinado.

13) Aluminium

El aluminio es un metal suave y ligero, con un color plateado vivaz, debido a una capa sutil de oxidación que se forma rápidamente cuando se expone al aire. Es sumamente resistente a la corrosión atmosférica: por esta razón no requiere ninguna pintura de protección, aunque puede ser tratado igualmente con una amplia gama de revestimientos, desde las lacas hasta las anodizaciones coloreadas. El aluminio es no magnético, no tóxico y no inflamable.

14) Latón

Con el nombre de latón se denomina una aleación de cobre y zinc, que compone la familia más amplia del bronce. Es un metal muy útil, gracias a su resistencia y facilidad de tratamiento. En los productos Agape de latón se aplican tratamientos superficiales de cromado brillo o satinado.

15) Cristal

Formado esencialmente por silicatos, se obtiene por fusión de arena silícea con óxidos y carbonatos. Gracias a la transparencia perfecta, a la inalterabilidad y a la capacidad de reaccionar a la luz de manera siempre cambiante, el cristal se utiliza especialmente en las combinaciones con otros materiales que componen la gama de productos Agape. Las uniones entre las partes se realizan con adhesivos especiales que garantizan la perfecta transparencia y la continuidad del material.

Certificazione / Certification

I prodotti Agape possono contribuire a soddisfare i requisiti dei crediti LEED®. Agape products can contribute to the allocation of LEED® credits. Für die Produkte von Agape können LEED®-Punkte zuerkannt werden. Les produits Agape peuvent contribuer à satisfaire les requis nécessaires pour l'évaluation LEED®. Los productos Agape cumplen con los requisitos exigidos por LEED®.



Agape è socio Green Building Council Italia / Agape is member of the Italian Green Building Council / Agape ist Mitglied des Green Building Council Italien / Agape est membre de Green Building Council Italie / Agape es miembro de Green Building Council Italia

Graphic design: Designwork
Copywriting: Daniele Varelli
Translation: StudioIntra
Photography: Andrea Ferrari,
Filippo Bamberghi, Studio Haas,
ContrattiCompany, F2,
Andrea Gnesato, Luca Marri,
Giorgio Possenti, Leo Torri,
Max Zambelli, Marzio Bondavalli
Collezione tessile: IVANOREDAELLI
Colour separation: Lucegroup
Printed by: EPX srl
Bortolazzi Stei

Agape srl © ristampa 04.2016



Agape srl
via A. Pitentino, 6 / 46037 Governolo
Roncoferraro (MN), Italy
T +39 0376 250311 / F +39 0376 250330
info@agapedesign.it
www.agapedesign.it

